

Ø8 x 35		Ø8 x 24			
A 35x	B 35x	C 35x	D 35x	E 6x	F 6x

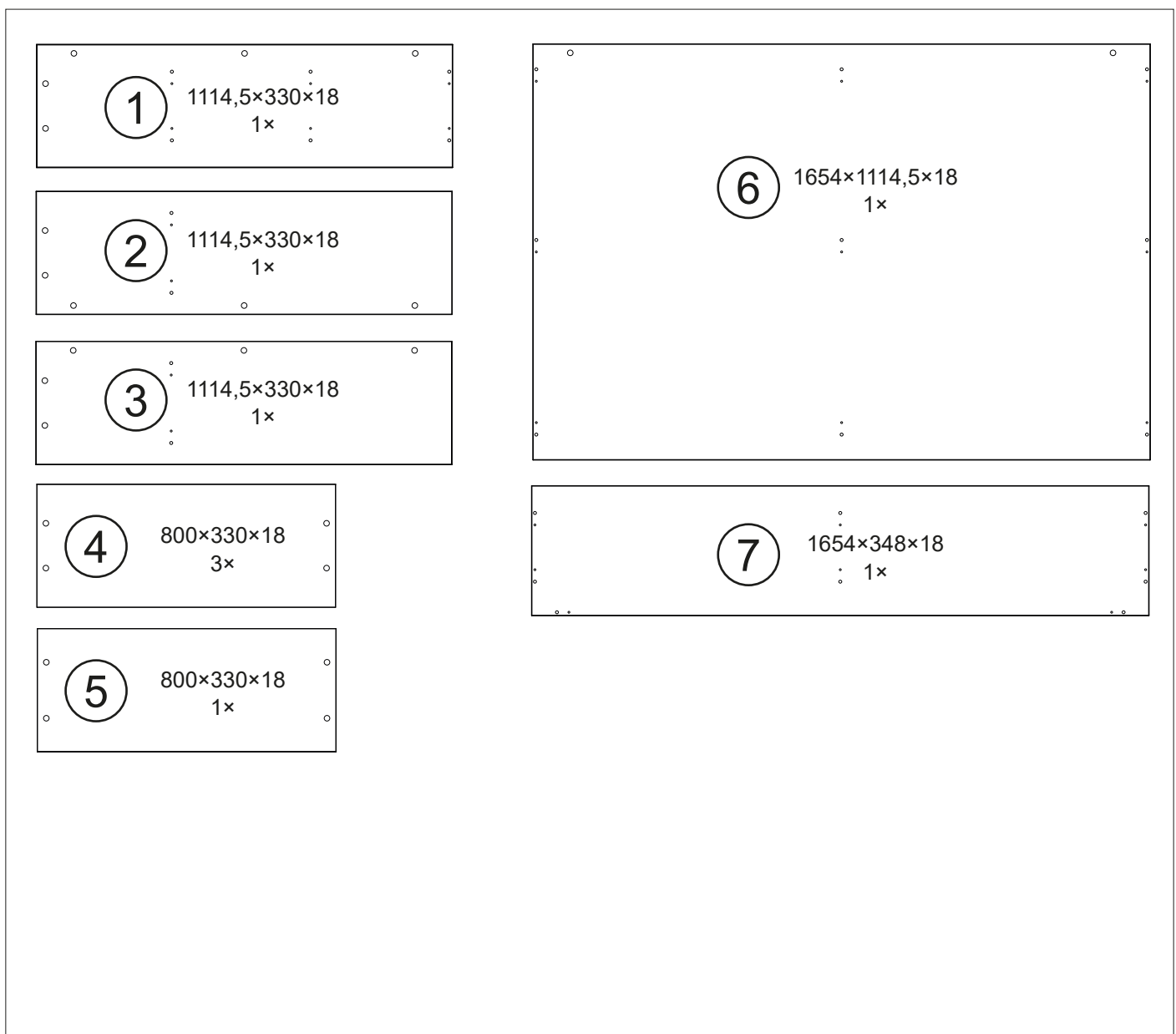

1

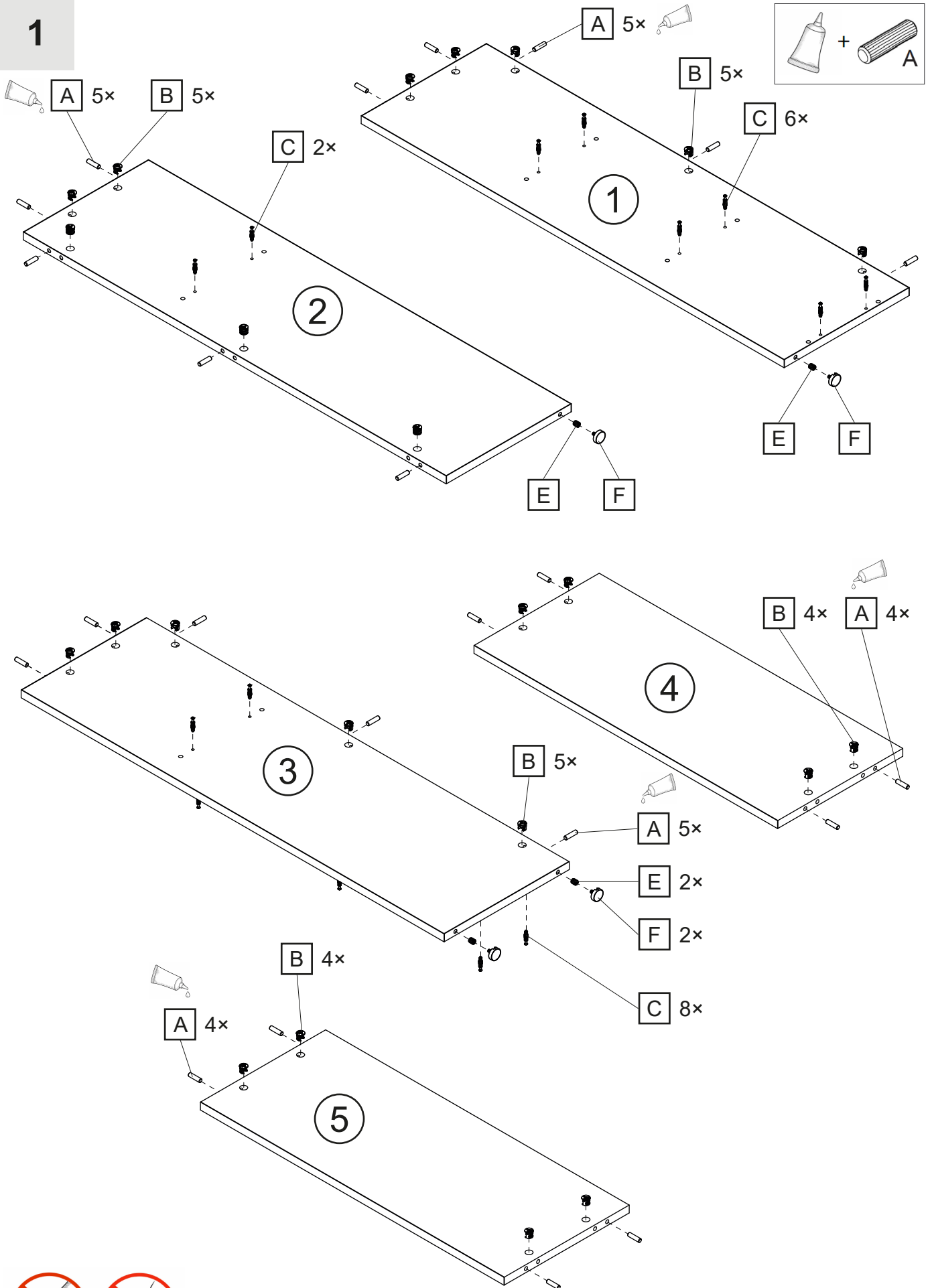
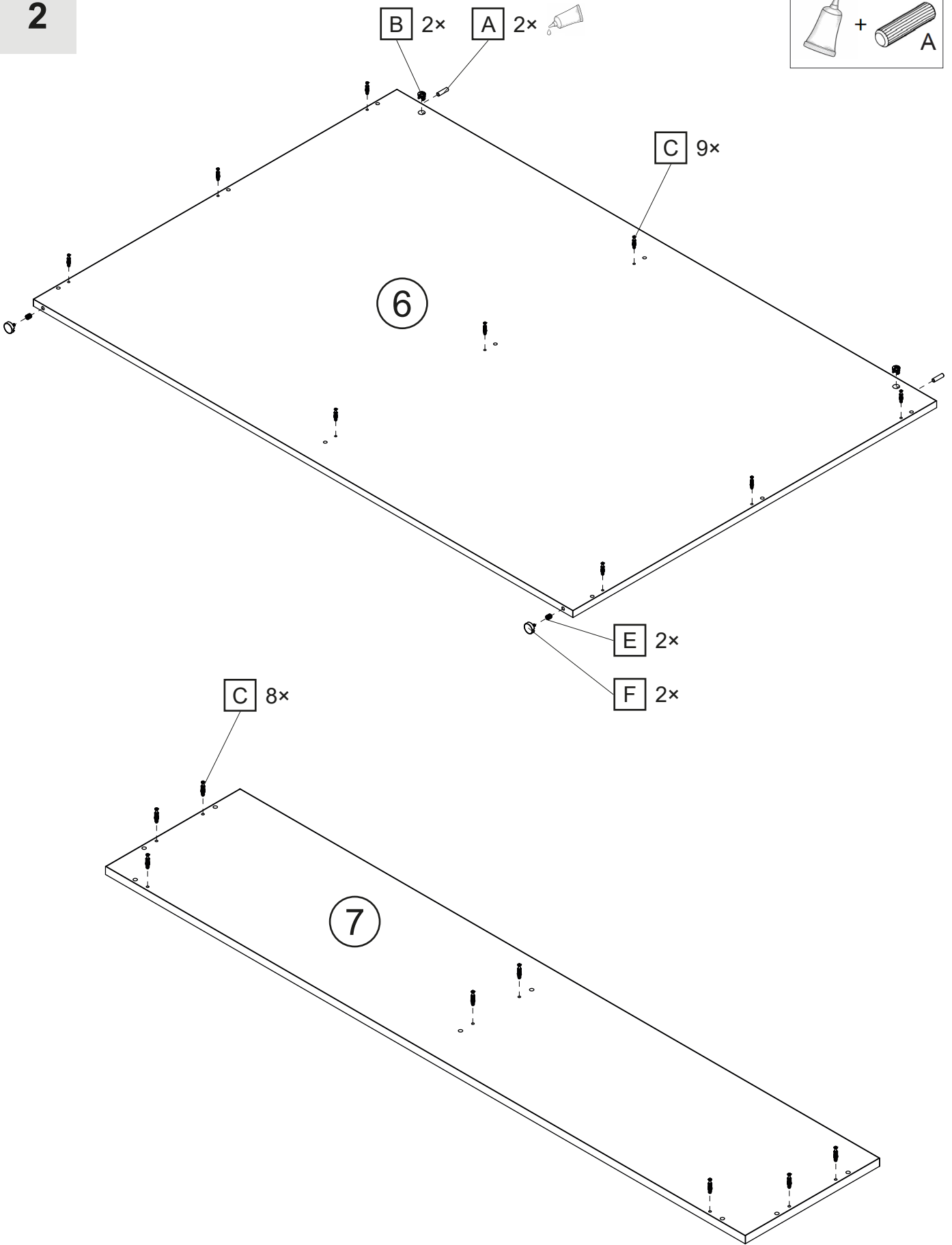
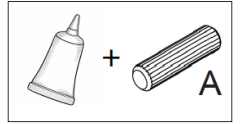

2



3

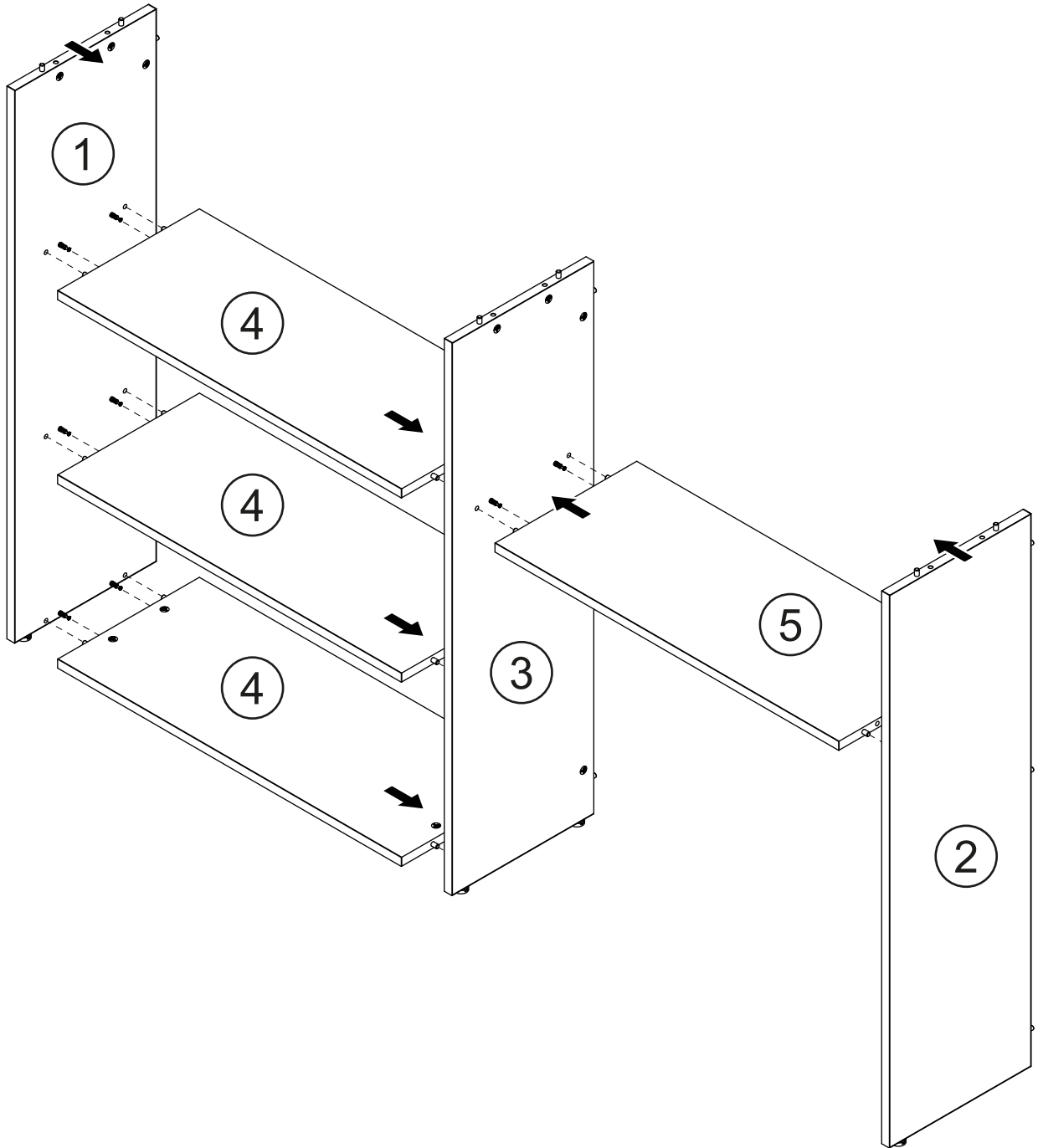

4

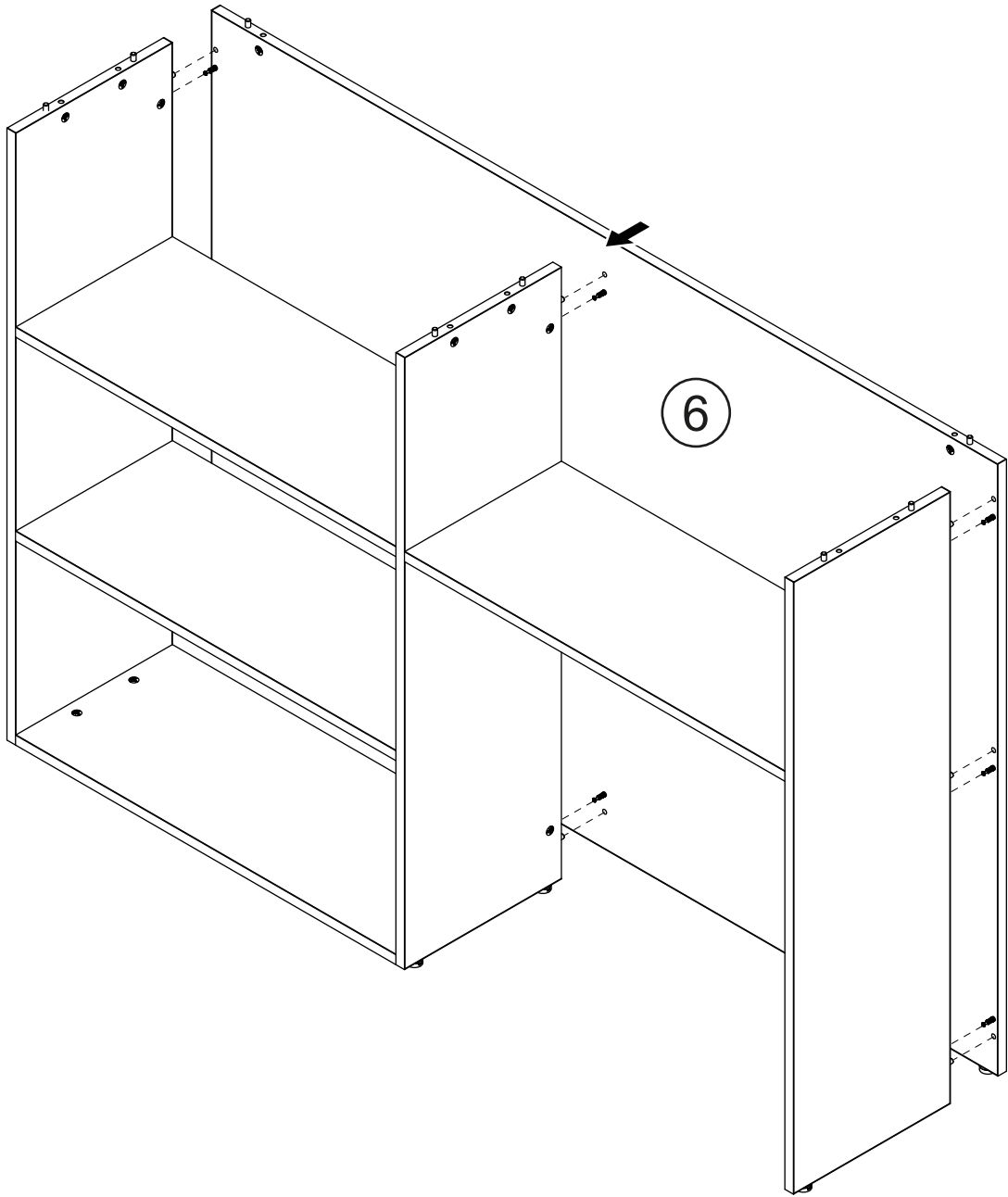



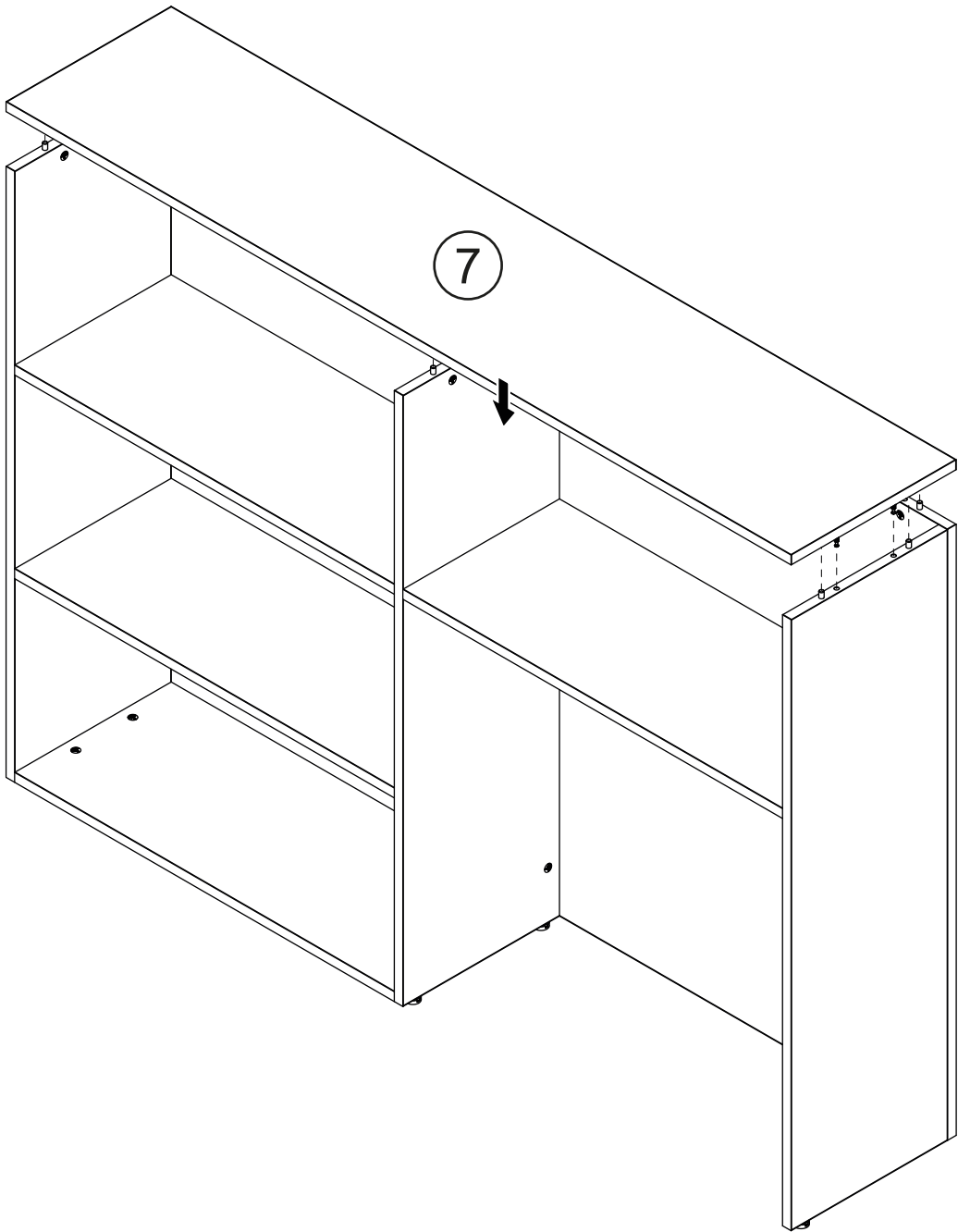



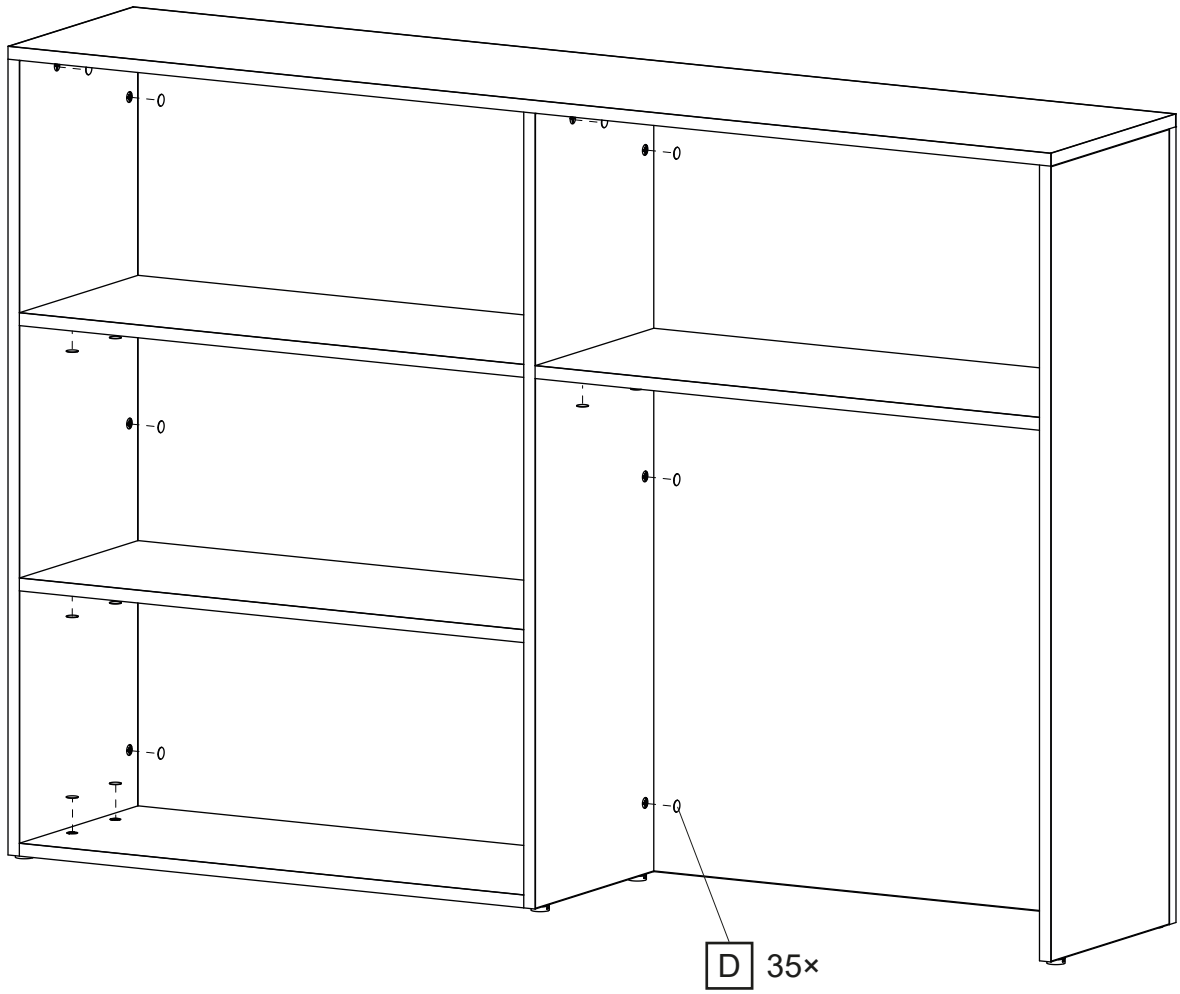

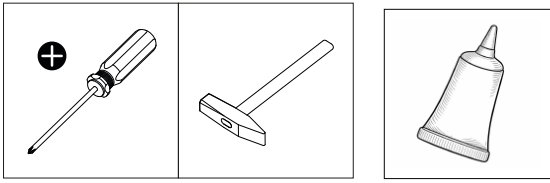
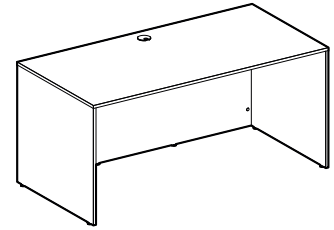
5



6





						
Ø8 x 35		Ø8 x 24				
A 16x	B 16x	C 16x	D 16x	E 6x	F 6x	G 1x

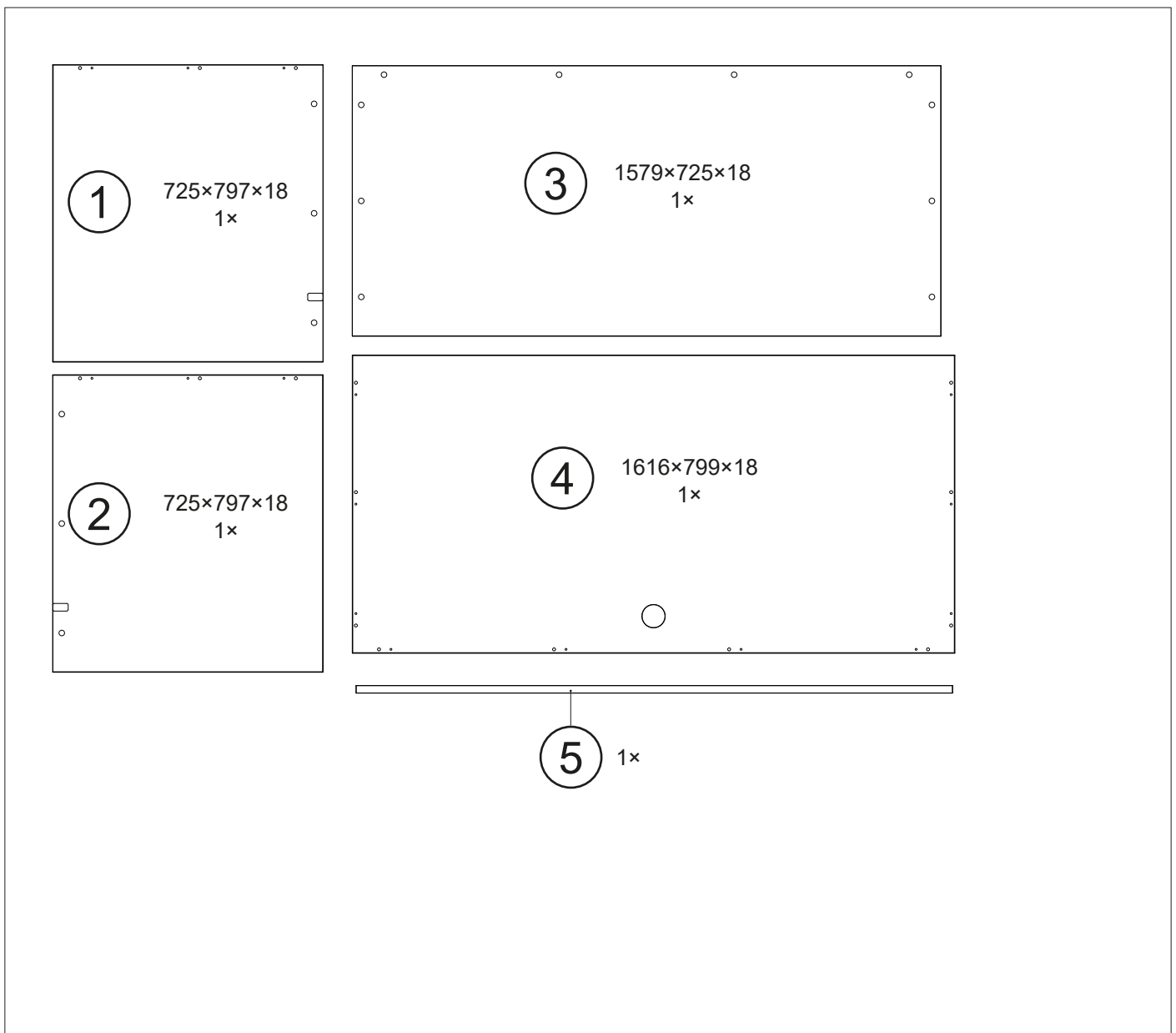

1

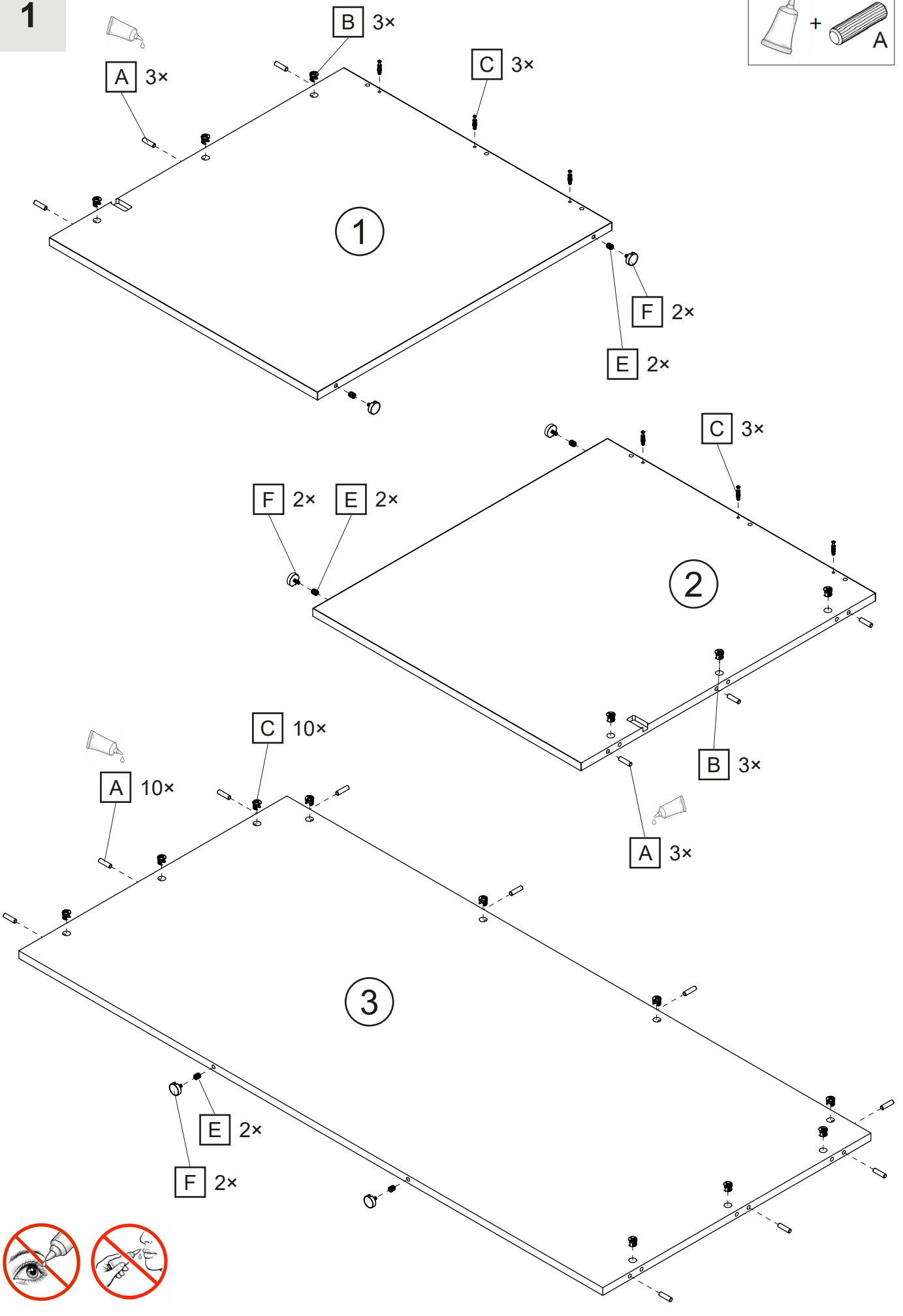
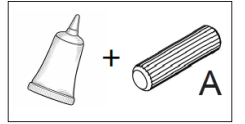

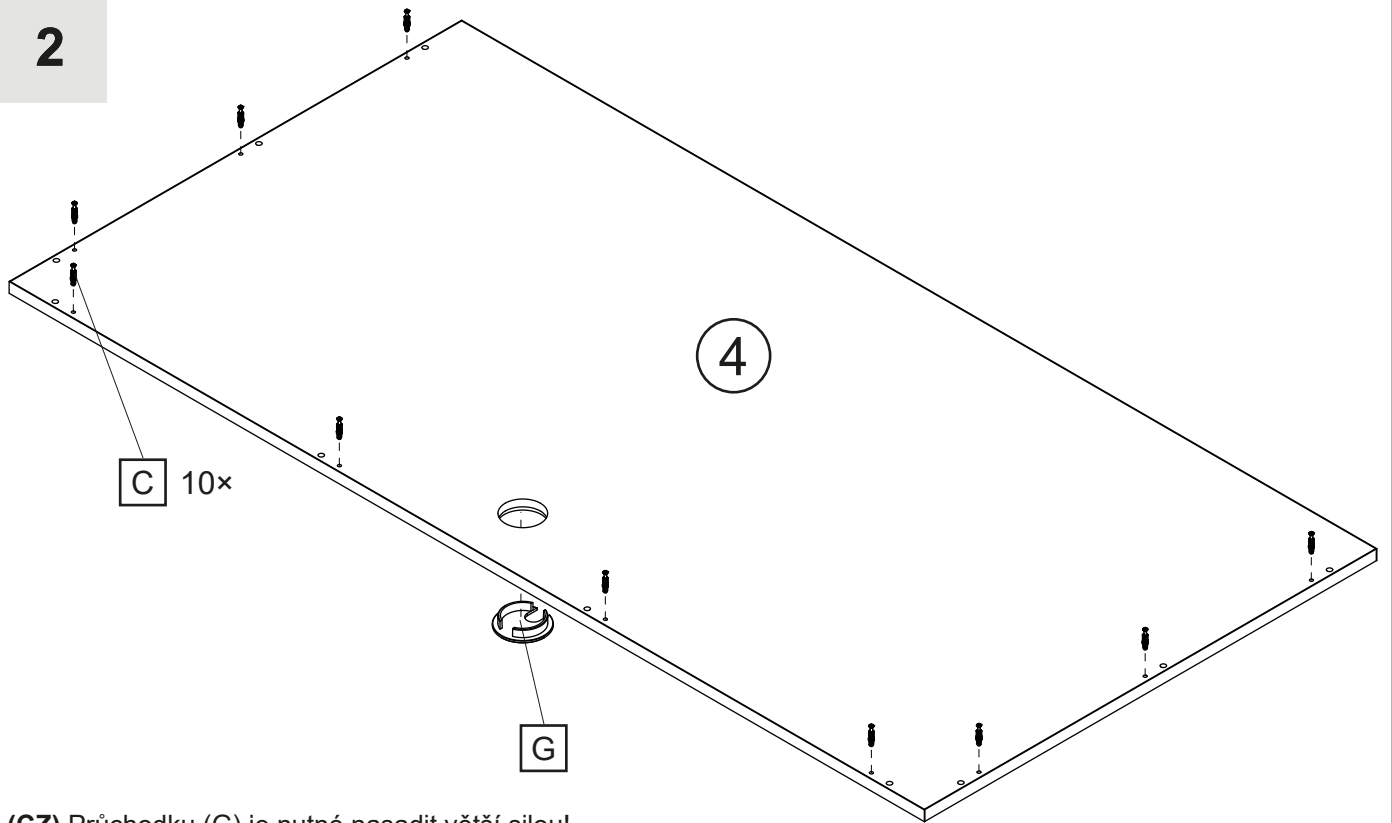
**2**

- (CZ)** Průchodku (G) je nutné nasadit větší silou!  
**(SK)** Priečodku (G) je potrebné nasadiť väčšou silou!  
**(PL)** Przelotkę (G) należy zamontować z użyciem większej siły!  
**(DE)** Die Durchführung (G) muss mit größerer Kraft montiert werden!

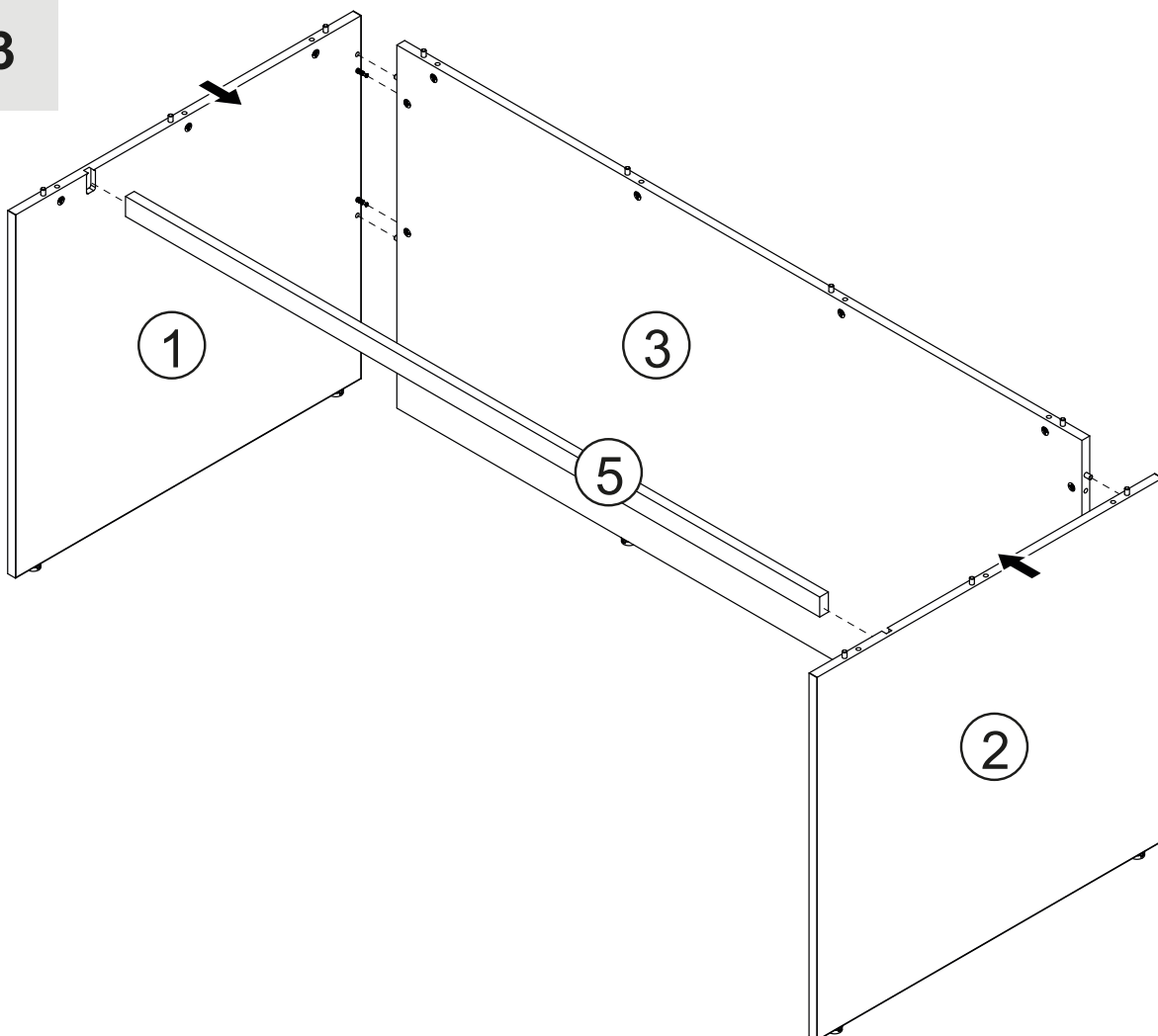
**3**

4

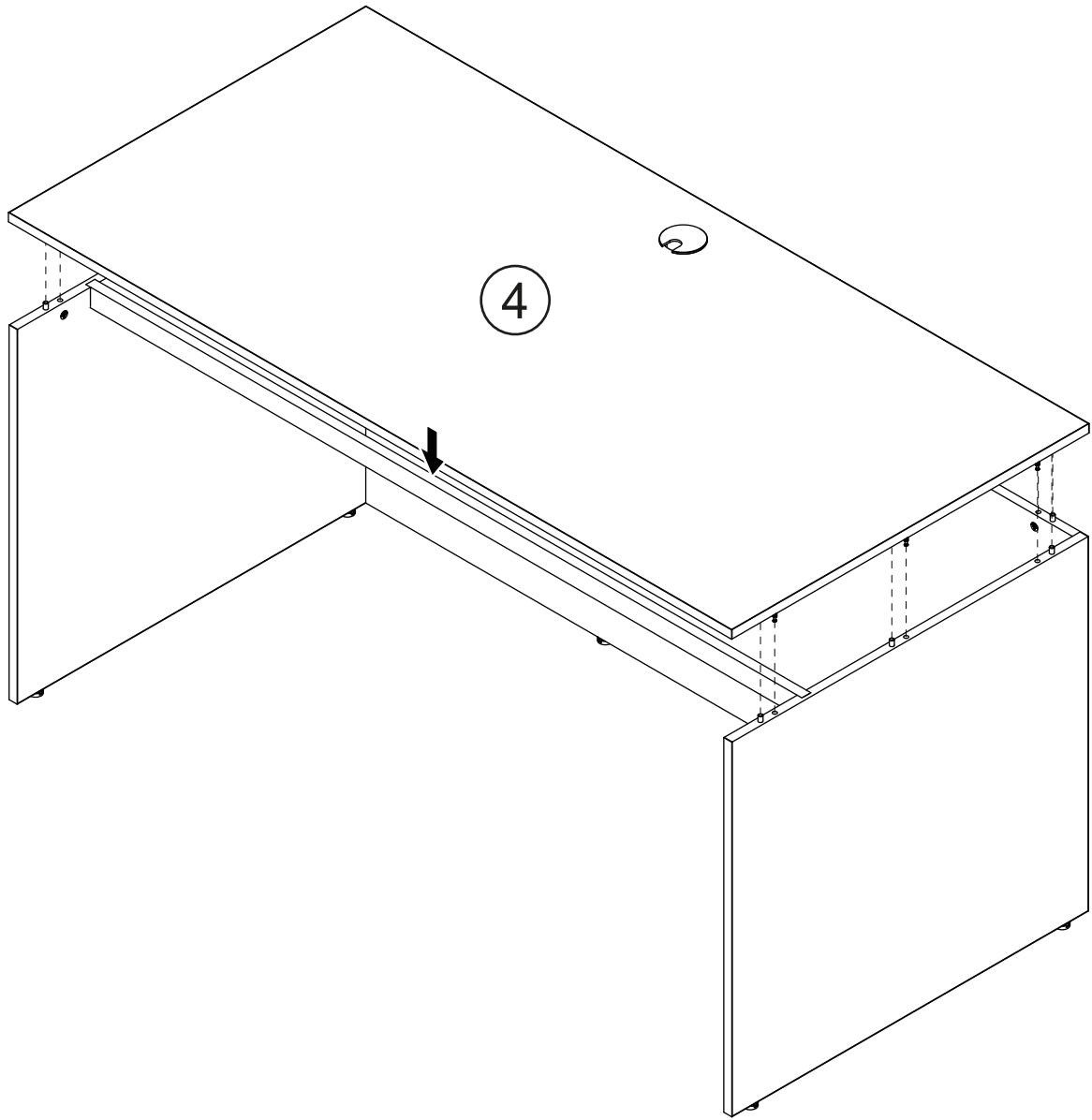

5

