







Ø8 × 35		Ø8 × 24
A 48×	B 28×	C 28×
		
	Ø3,5 × 16	
I 12×	J 12×	

			
E 12×	F 4×	G 6×	H 12×



1

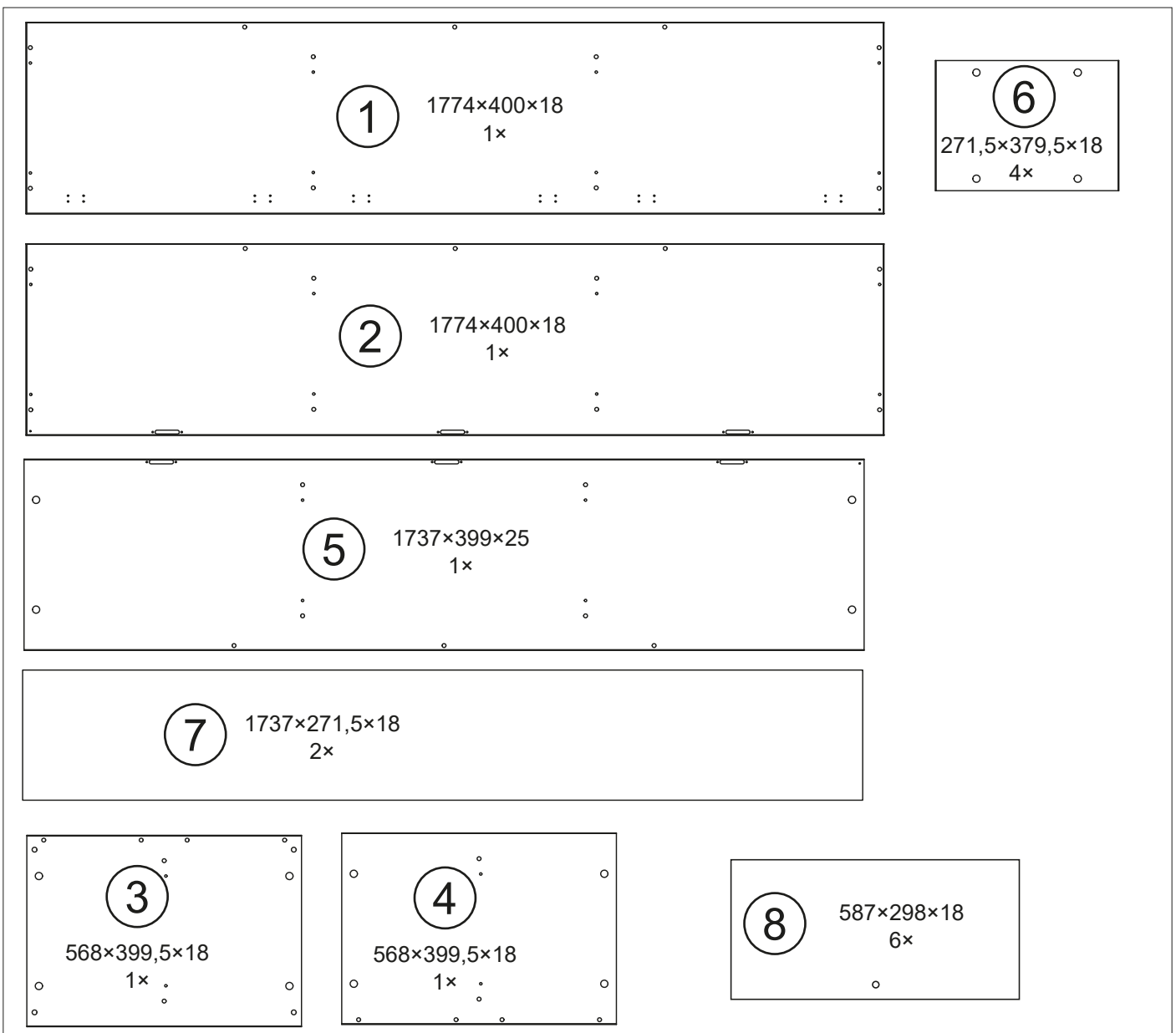
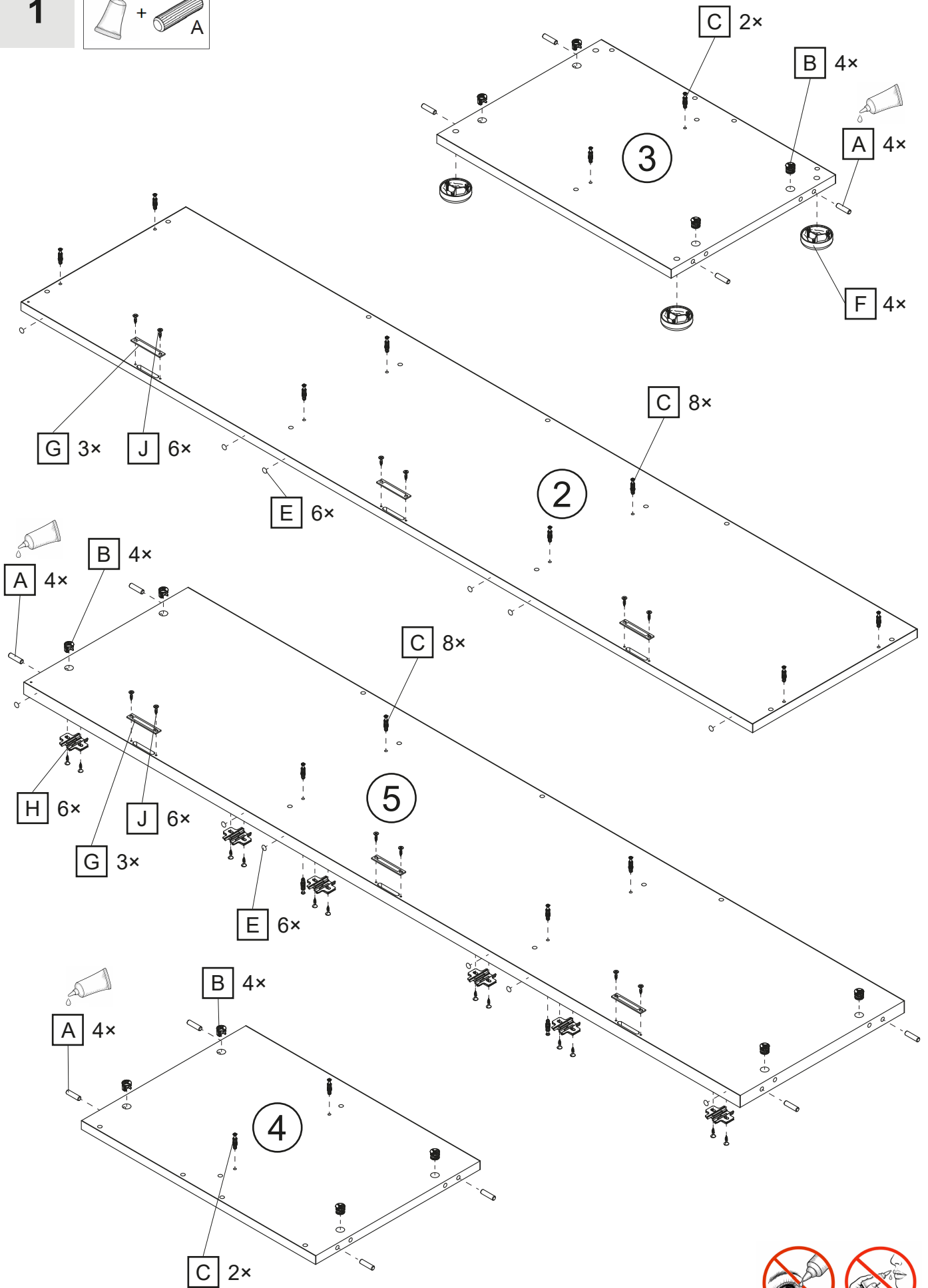
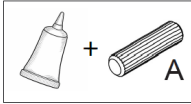

2

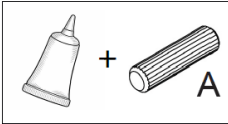

I 2x

C 8x

8

H 6x

1

A 10x

7

B 4x

A 4x

6



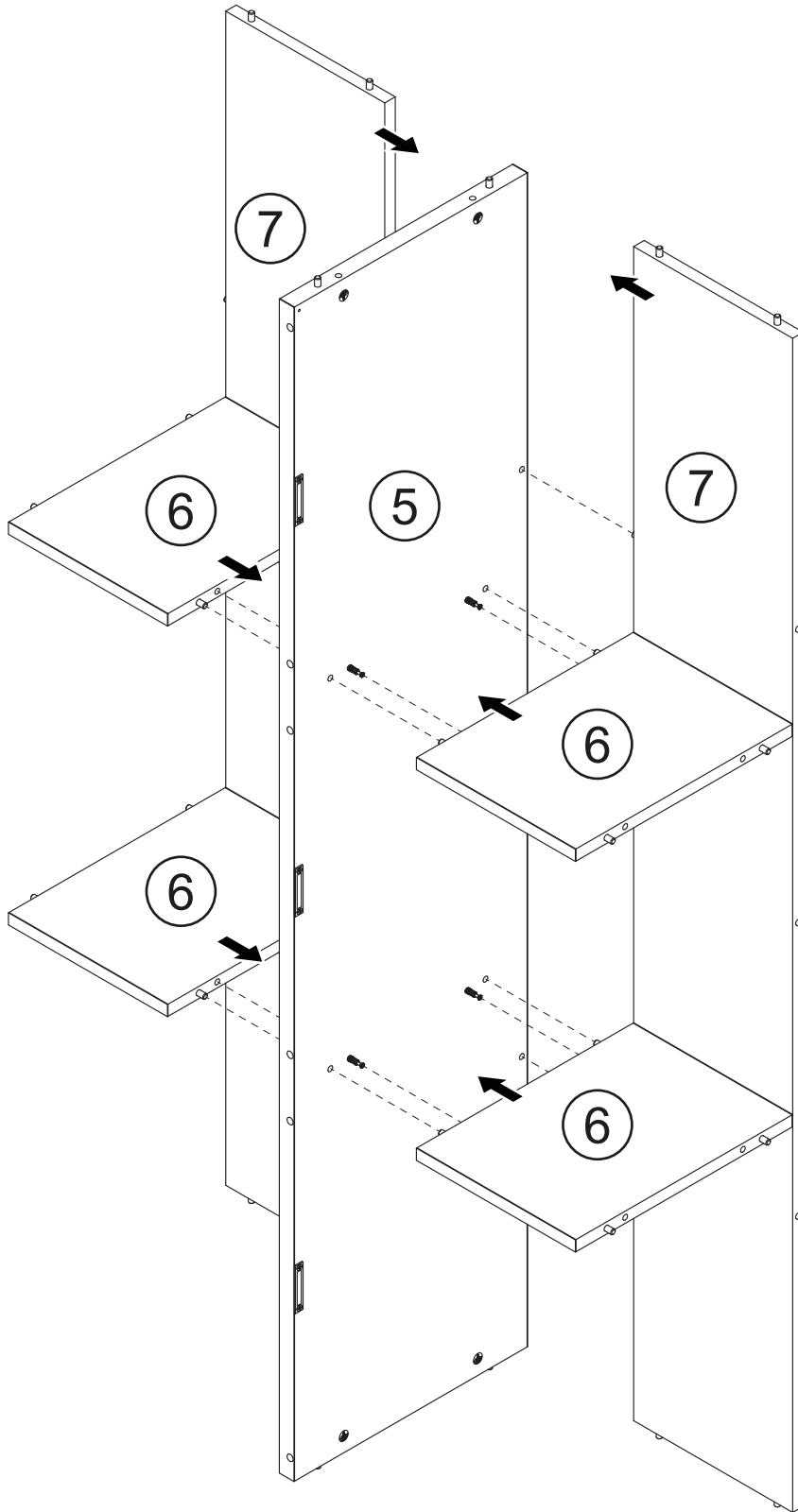

4

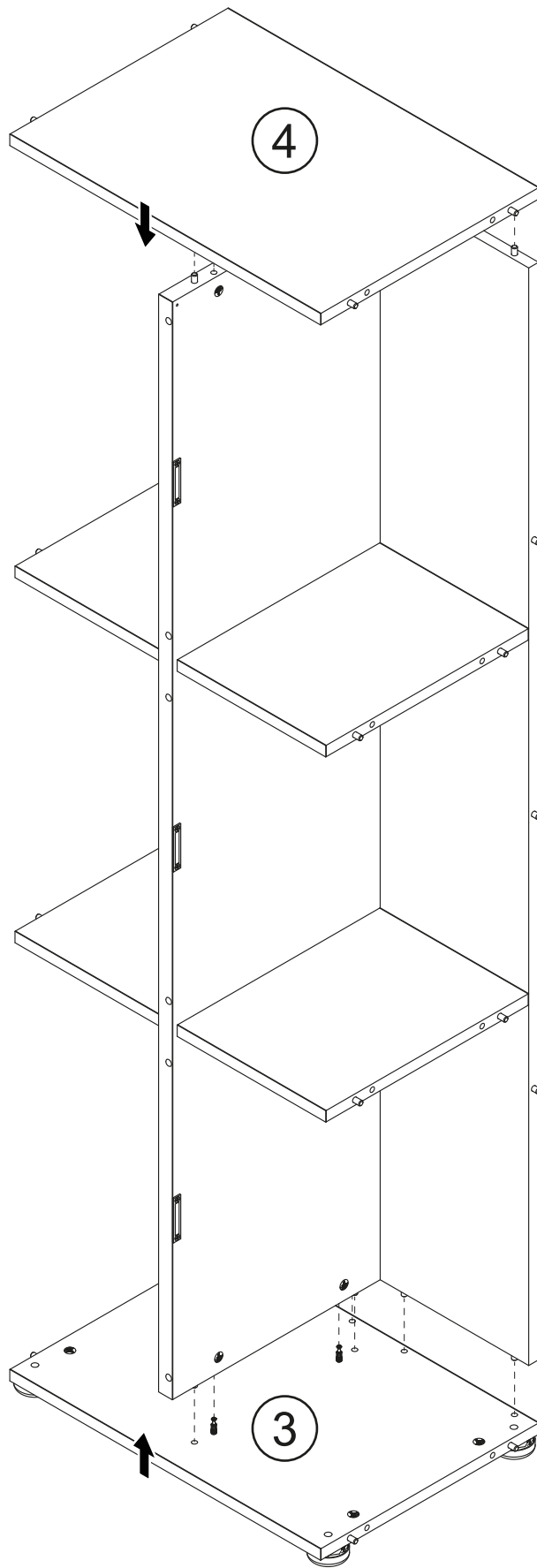

5

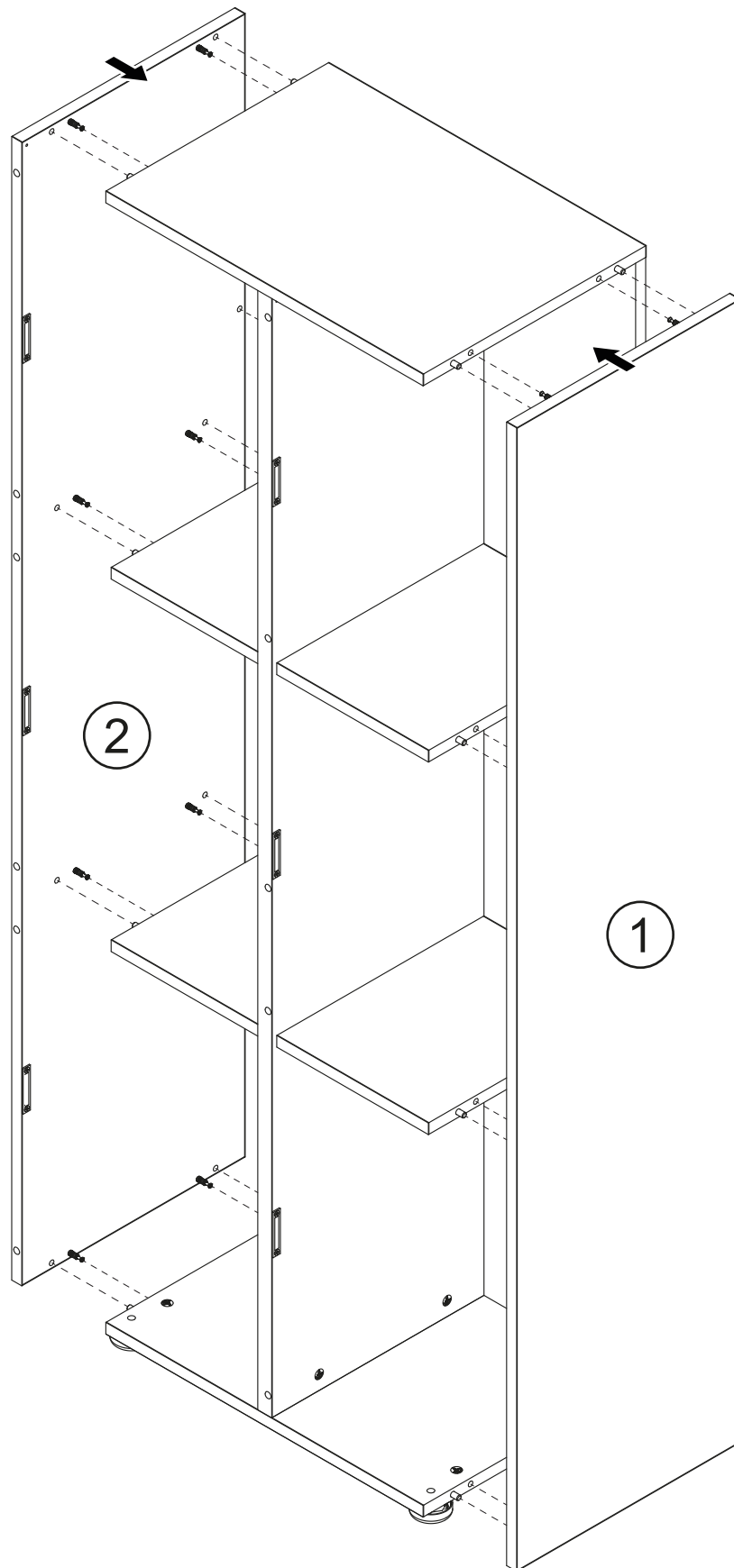

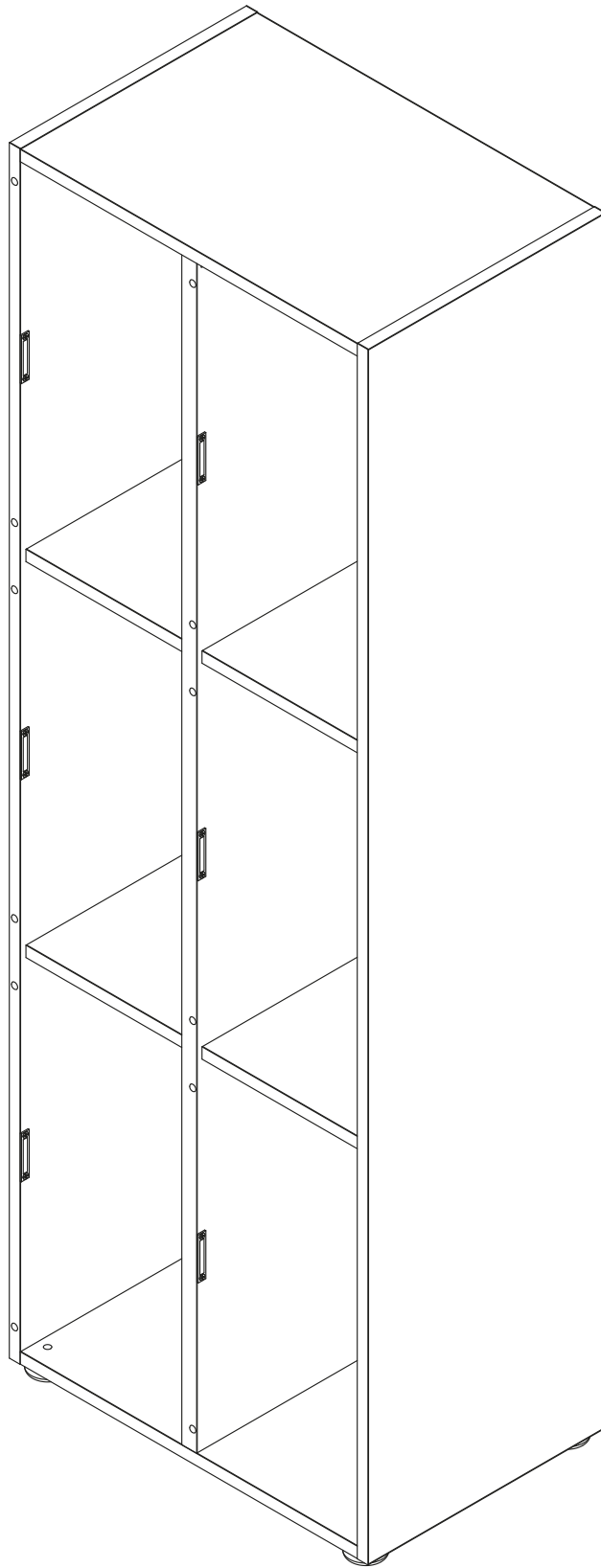

7

