

Ø8 x 35		Ø8 x 24				
A 26x	B 12x	C 12x	D 12x	E 8x	F 8x	G 5x

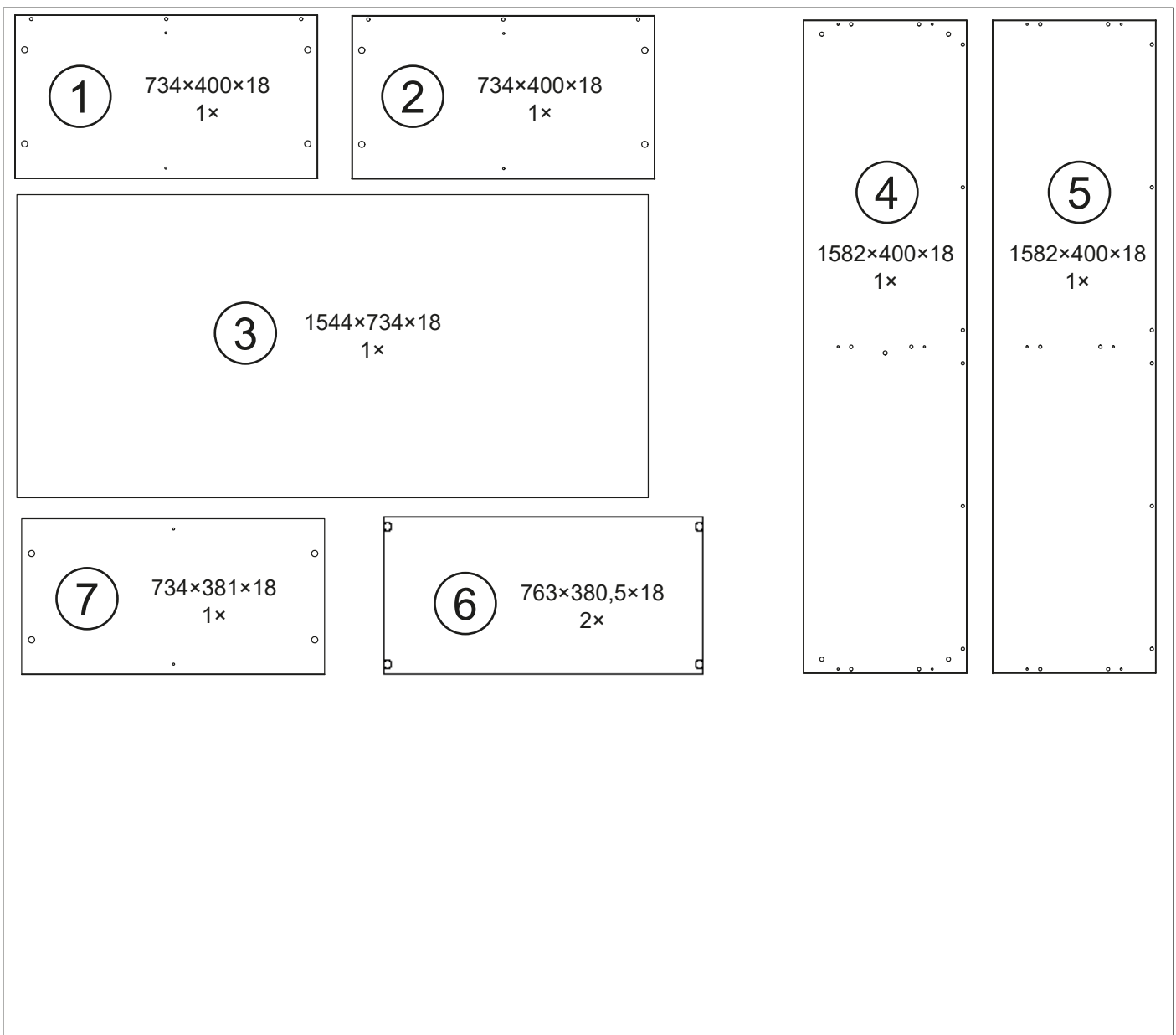

1

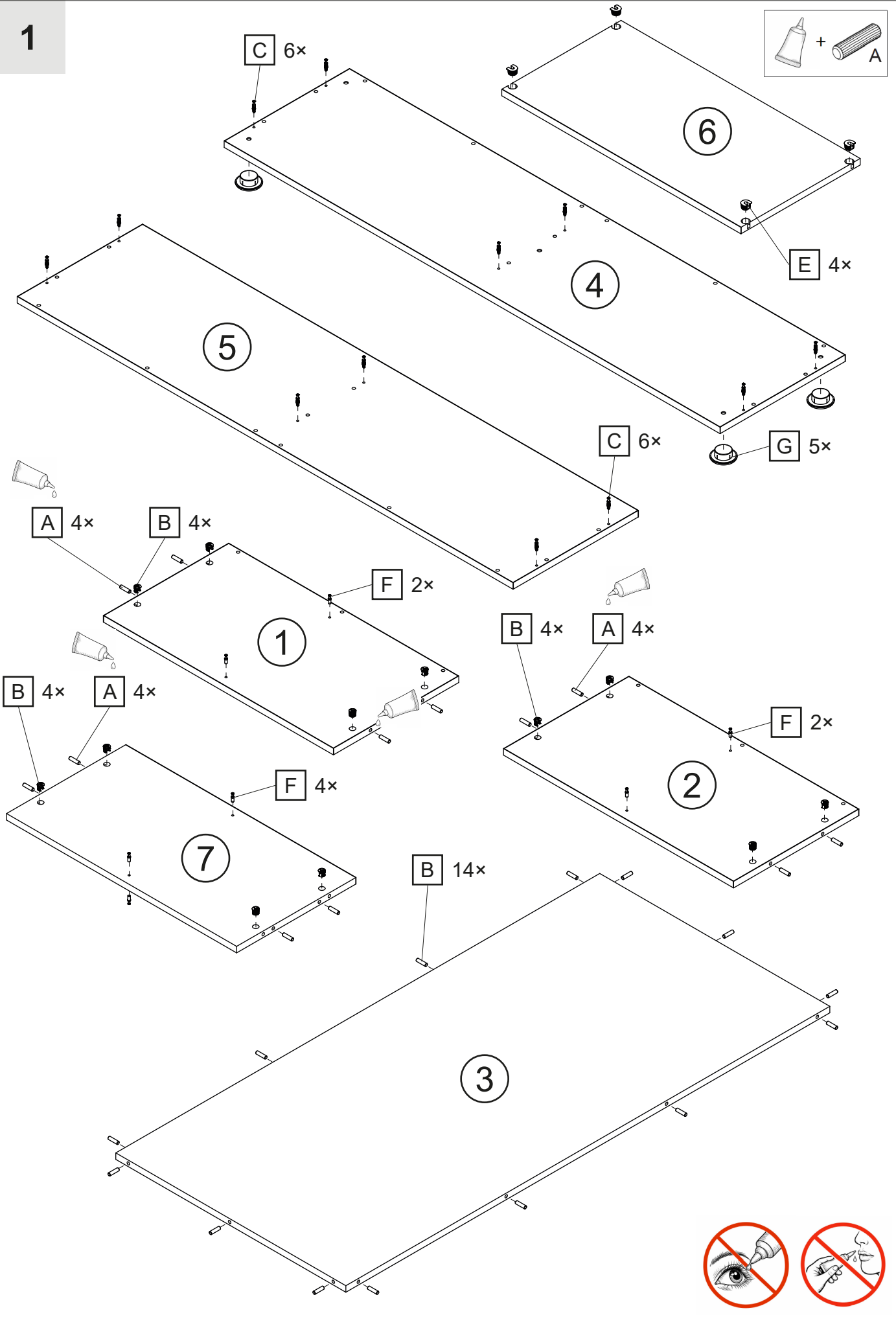
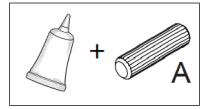
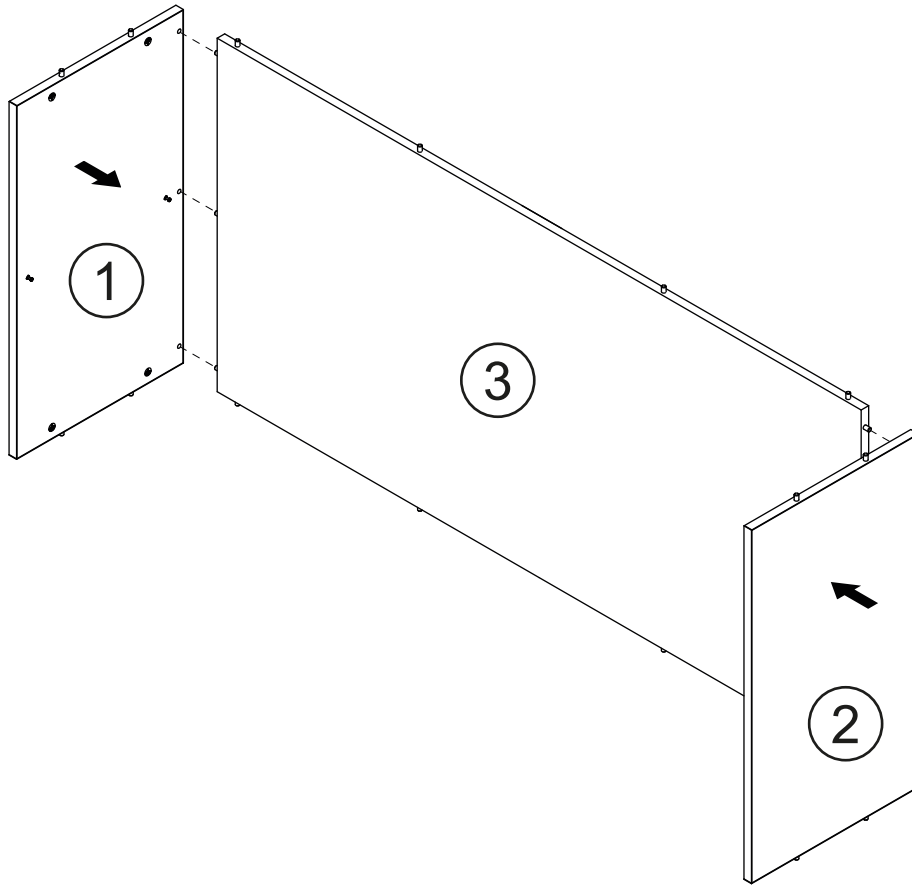

2



3

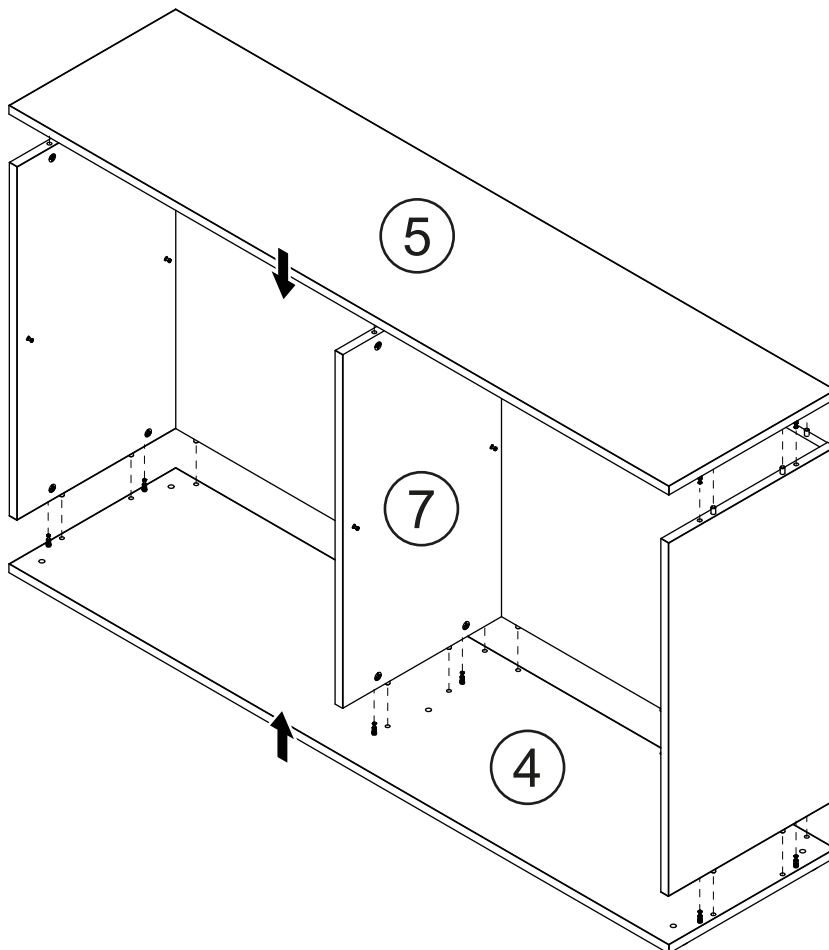

4

