

Ø8 x 35		Ø8 x 24				
A 16x	B 10x	C 10x	D 10x	E 4x	F 4x	G 1x

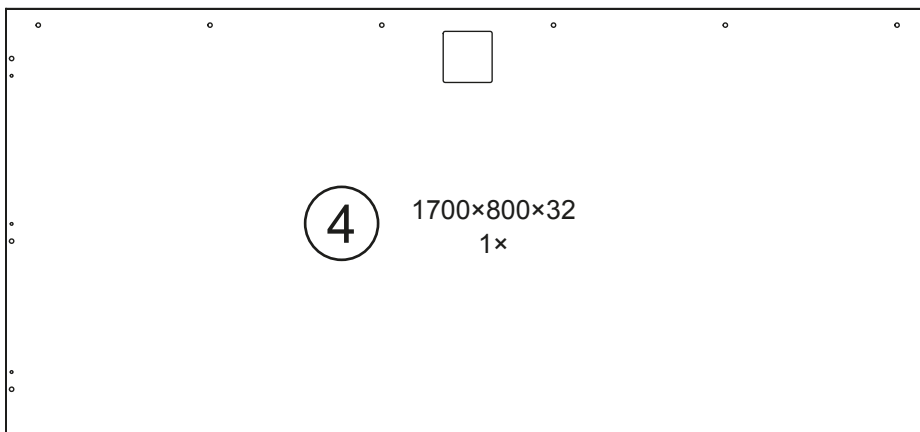

1

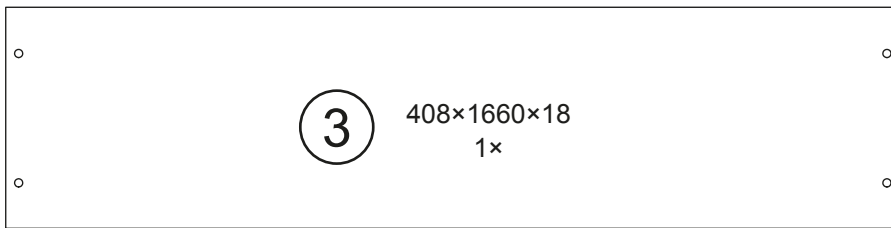
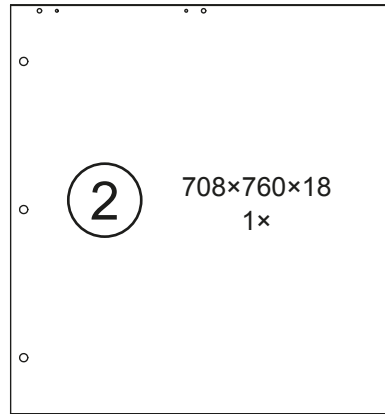
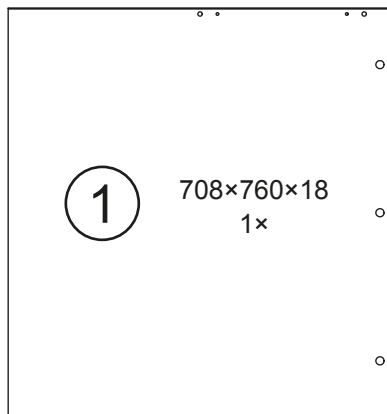
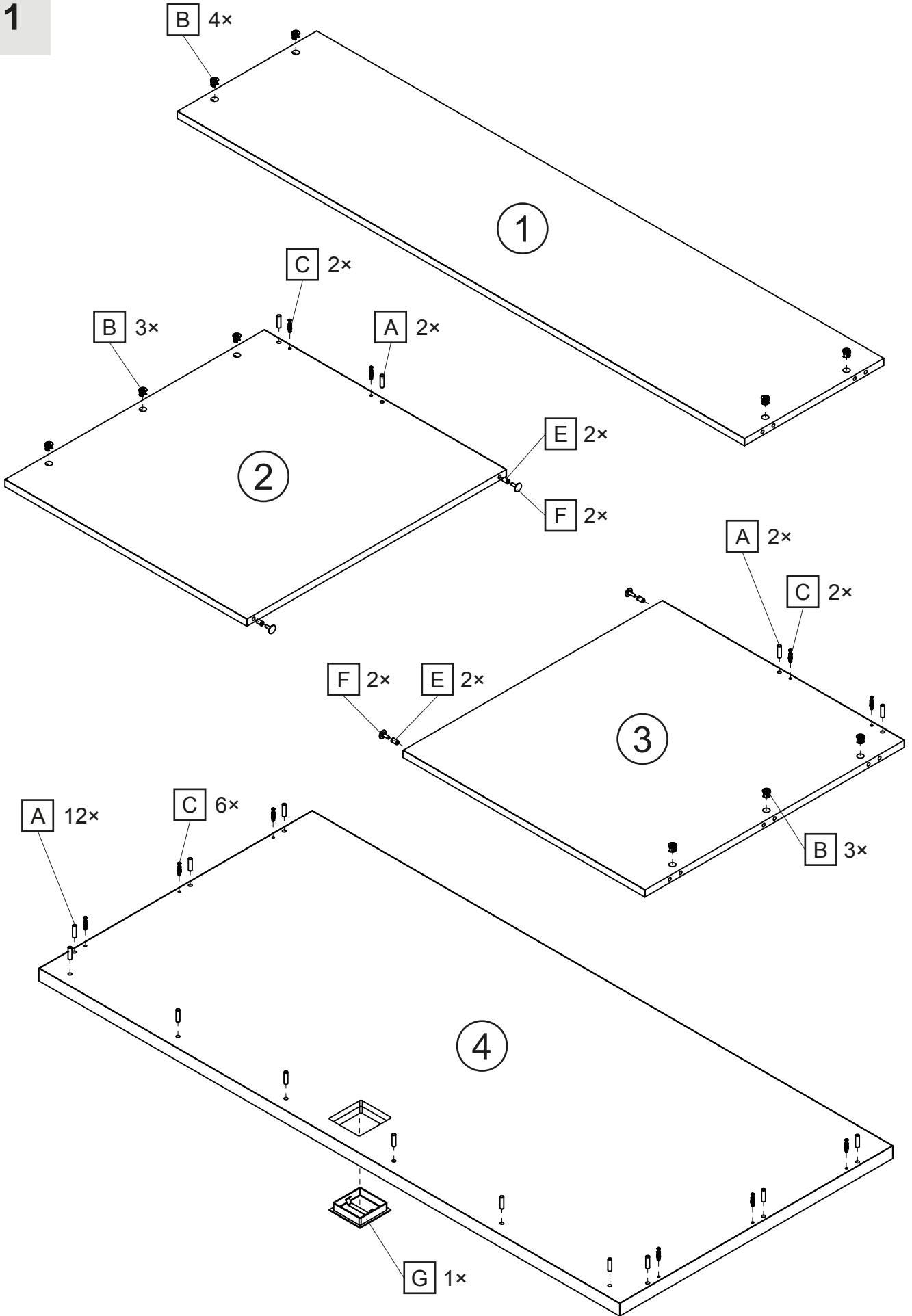
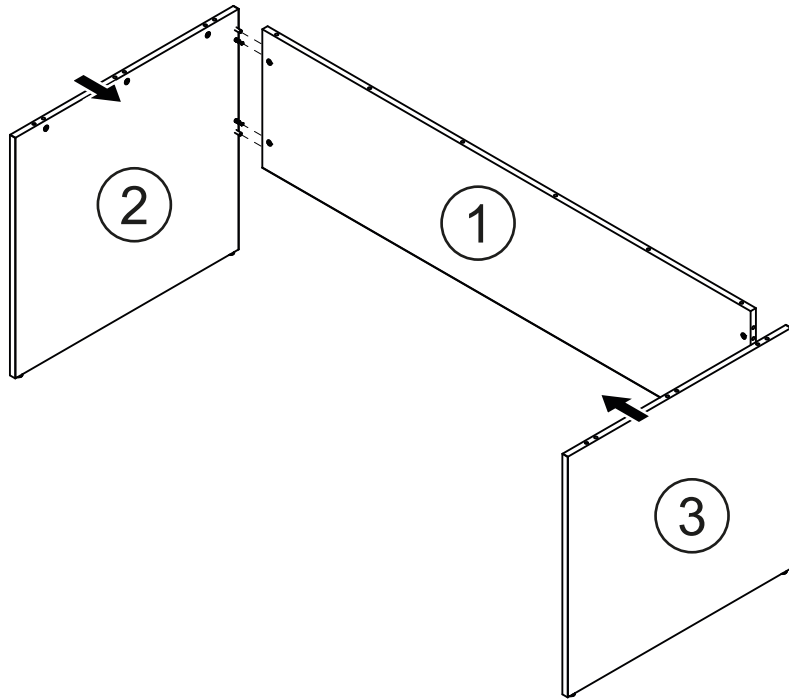

2



3

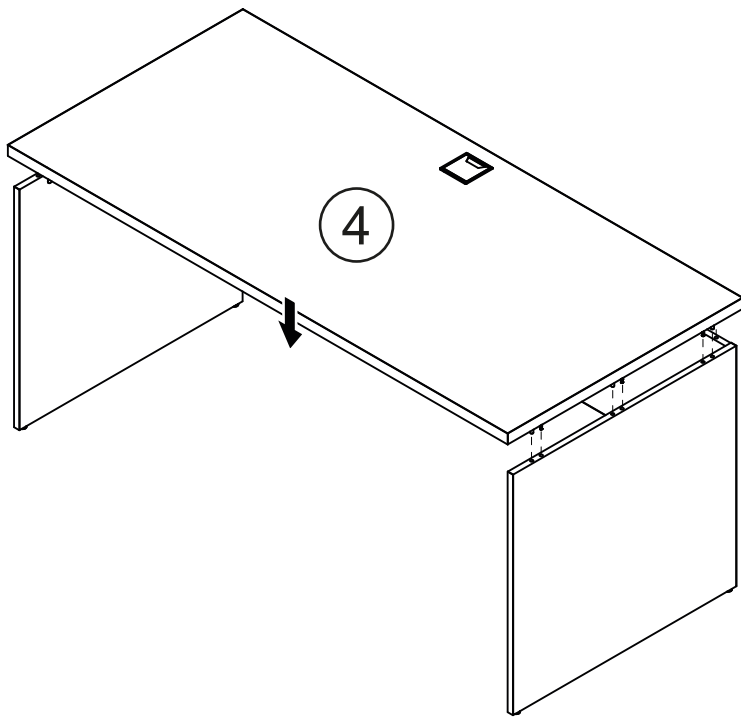

4

