

Ø8 × 35		Ø8 × 24				M4 × 25	Ø3,5 × 35
A 20×	B 20×	C 20×	D 20×	E 4×	F 2×	G 2×	H 4×

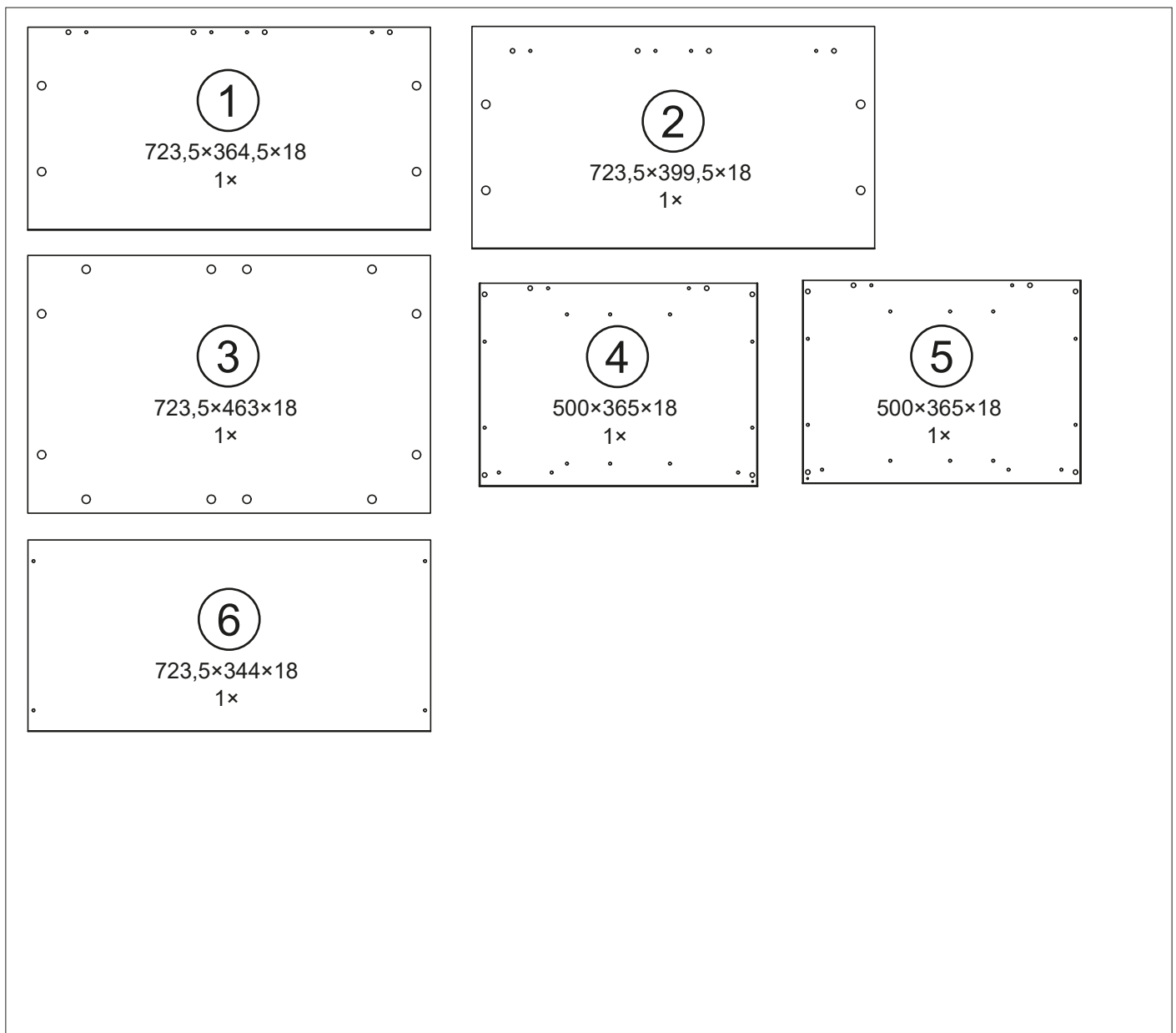

1

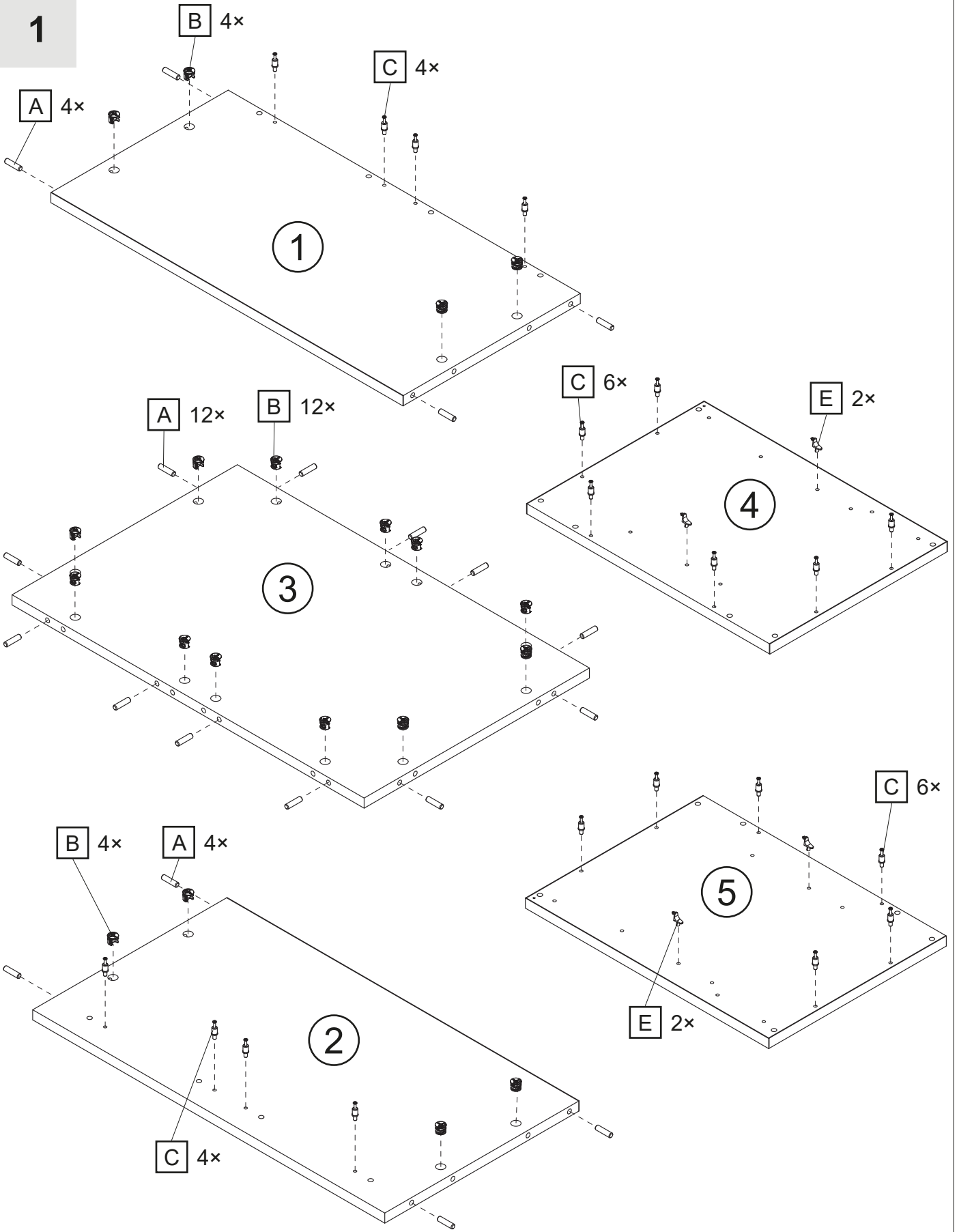
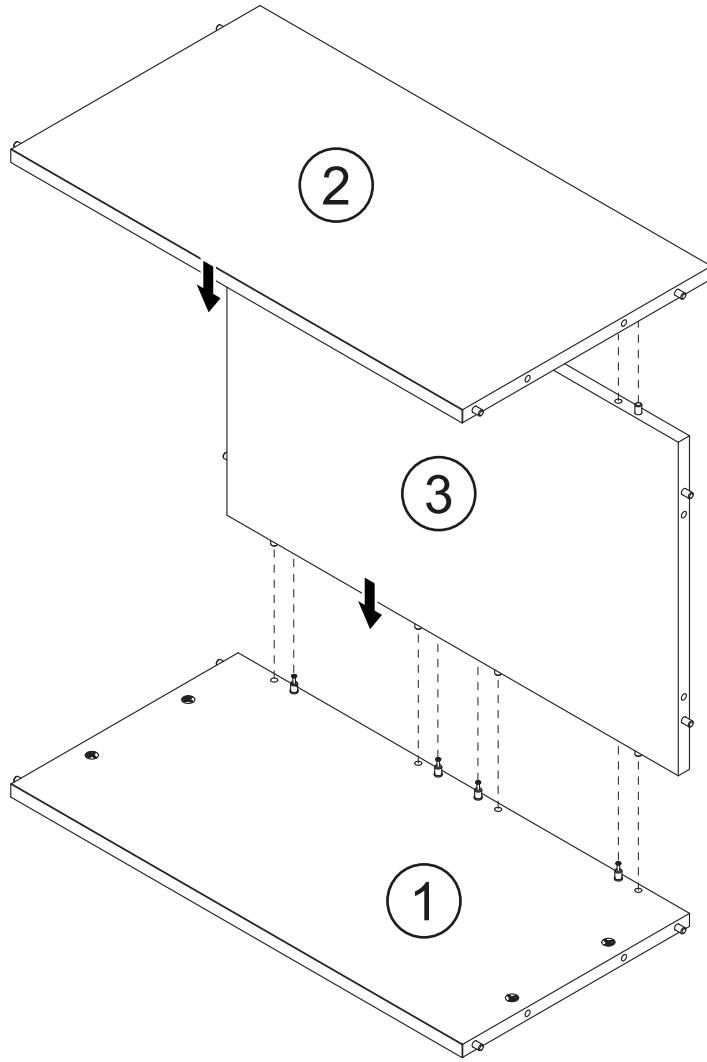

2



3

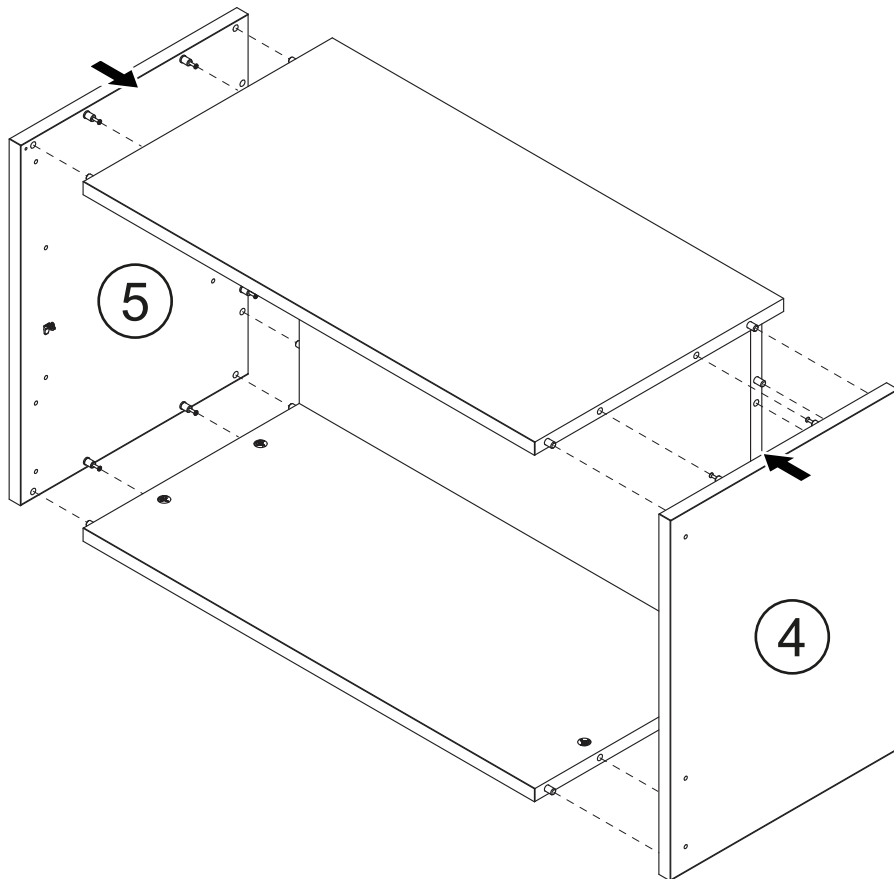

4

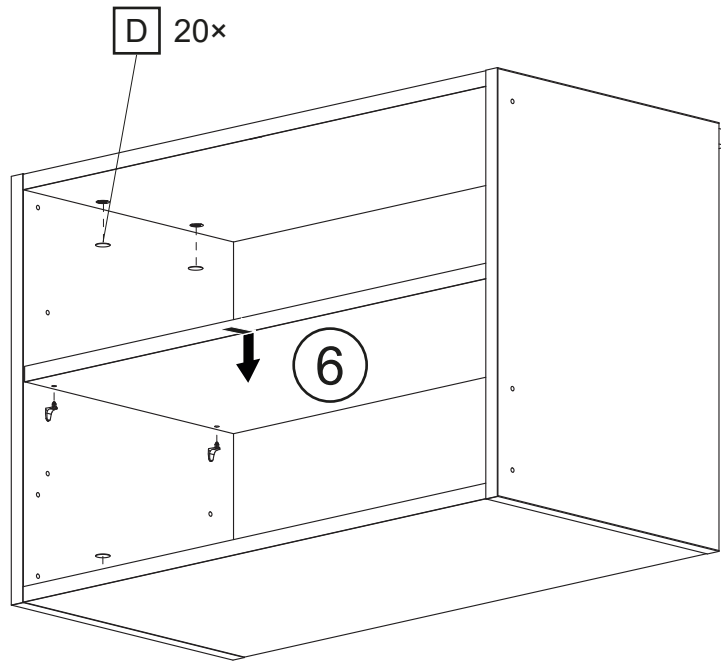

5

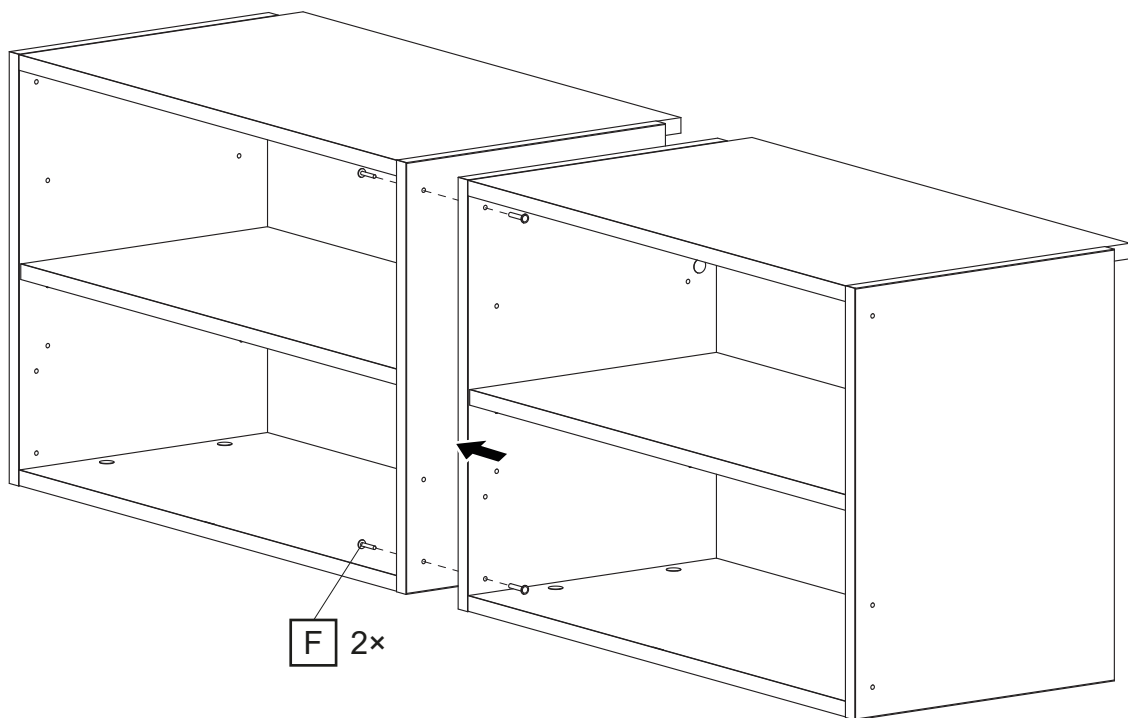

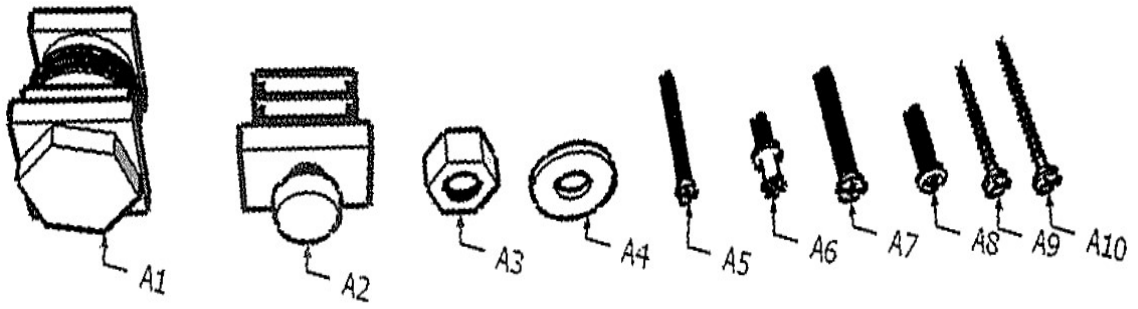

1	2	A2	A5	A6	A8	A9
1x	1x	2x	4x	16x	4x	4x

