

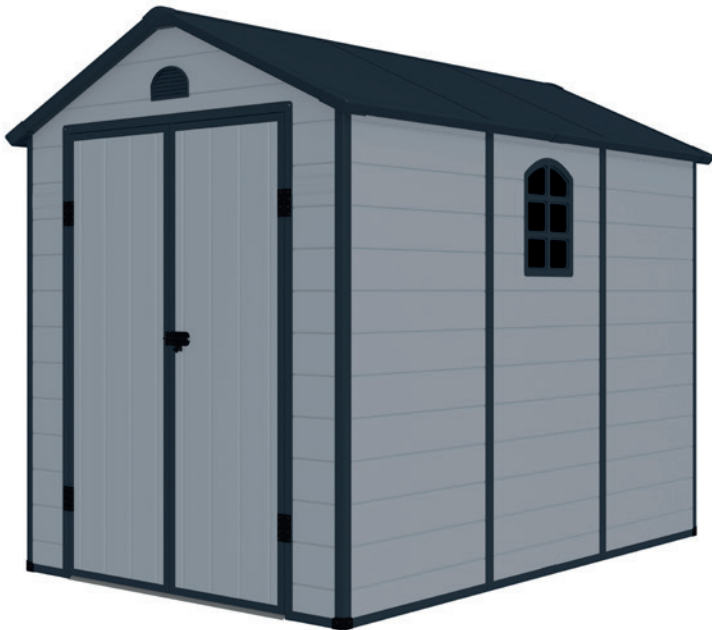

Manual

Garden House G21

Boston 523



EN DE CZ SK HU PL

۲۷



Thank you for purchasing our product.

Before using this unit, please read this manual.

Assembly instructions:

Prior to the assembly please read all instructions and information carefully.

Check whether you have all parts which are necessary for the assembly.

The plastic shed has to be anchored to its base in order to prevent damage. The base is not included in the delivery and it has to be built separately.

Please mind your own safety.

1. Assemble the shed in dry, calm conditions. Do not assemble in windy conditions.
2. 2-4 persons are required for the assembly of this plastic shed.
3. Use protective clothing, gloves and goggles when assembling the shed.
4. During the assembly no children or pets should be present in the working area.

Care and maintenance:

1. Keep the doors closed and locked when the shed is not in use to prevent wind damage.
2. Clean the house using cloth and water.
3. Always remove fallen leaves from the roof as soon as possible to prevent them staining the roof. In case of snowfall remove the snow from the roof regularly. Large amounts of snow on the roof can damage the shed.
4. The house is not designed for living but only for storage purposes. Do not store hot items, such as recently used grills, blowtorches and volatile chemicals in the shed.



Vielen Dank für den Kauf unseres Produktes.

Bevor Sie dieses Gerät verwenden, lesen Sie diese Anleitung.

Montageanleitung:

Bevor Sie mit der Montage beginnen, lesen Sie sorgfältig alle Anweisungen und Informationen durch.

Überprüfen Sie, ob Ihnen alle notwendigen Teile für den Bau des Gartenhauses zur Verfügung stehen.

Das Gartenhaus muss ordnungsgemäß an der Grundplatte verankert werden, damit es bei starkem Wind nicht zur dessen Beschädigung oder Zerstörung kommt. Die Grundplatte ist nicht im Lieferumfang enthalten, diese muss getrennt gebaut werden.

Achten Sie auf Ihre Sicherheit.

1. Die Montage des Hauses ist an einem trockenen Ort und bei guten Wetterbedingungen durchzuführen.
2. Montieren Sie das Haus in 2-4 Personen.
3. Tragen Sie bei der Montage Schutzkleidung, Handschuhe und Schutzbrille.
4. Während der Montage sollten sich auf der Baustelle keine Kinder und Haustiere bewegen.

Pflege und Wartung:

1. Halten Sie die Tür geschlossen und verriegelt, um Beschädigungen durch Wind zu vermeiden.
2. Reinigen Sie das Haus mit einem Tuch und Wasser.
3. Entfernen Sie Laubblätter immer möglichst schnell, um Verfärbungen des Dachs zu vermeiden. Entfernen Sie den gefallenen Schnee regelmäßig vom Dach. Größere Schneemengen auf dem Dach können Schäden am Dach verursachen.
4. Das Haus ist nicht zum Wohnen, sondern zum Aufbewahren von Sachen vorgesehen. Im Gartenhaus dürfen keine heißen Gegenstände wie heiße Grills, UV-Lampen, flüchtige Chemikalien usw. gelagert werden.

Die deutsche Version der Anleitung ist eine genaue Übersetzung der Anleitung des Herstellers. Die in diesem Handbuch verwendeten Bilder dienen nur zur Illustration und können nicht genau das Produkt entsprechen.



Děkujeme za nákup našeho výrobku.

Před použitím si prosím přečtete tento návod.

Montážní návod:

Dříve, než začnete s montáží, pečlivě si prostudujte všechny pokyny a informace.

Zkontrolujte, zda máte všechny potřebné díly pro stavbu domku.

Domek musí být řádně ukotven k základové desce, aby nedošlo při silném větru k jeho poškození nebo zničení. Základová deska není součástí balení, je nutné si ji vybudovat samostatně.

Dbejte na svoji bezpečnost.

1. Montáž domku provádějte na suchém místě a za dobrých povětrnostních podmínek.
2. Domek montujte ve 2-4 lidech.
3. Při montáži používejte ochranný oděv, rukavice a ochranné brýle.
4. V době montáže by se po staveništi neměly pohybovat děti a domácí zvířata.

Péče a údržba:

1. Dveře od domku nechávejte zavřené a zamčené, aby nedošlo k poškození vlivem větru.
2. Domek čistěte za pomoci hadru a vody.
3. Vždy odstraňte spadané listí ze střechy co nejdříve, aby nedošlo k zbarvení střechy. Ze střechy pravidelně odstraňujte napadaný sníh. Větší nános sněhu na střeše může způsobit poškození střechy.
4. Domek není určen pro bydlení, ale pro ukládání věcí. V zahradním domku neskladujte horké předměty, jako např. rozpálený gril, opalovací lampy, těkavé chemikálie apod.

Česká verze návodu je přesným překladem originálního návodu výrobce.

Fotografie použité v manuálu jsou pouze ilustrační a nemusí se přesně shodovat s výrobkem.



Ďakujeme za nákup nášho výrobku.

Pred použitím si prosím prečítajte tento návod.

Montážny návod:

Skôr, než začnete s montážou, starostlivo si preštudujte všetky pokyny a informácie.

Skontrolujte, či máte všetky potrebné diely pre stavbu domčeka.

Domček musí byť riadne ukotvený k základnej doske, aby nedošlo pri silnom vetre k jeho poškodeniu alebo zničeniu. Základná doska nie je súčasťou balenia, je nutné si ju vybudovať samostatne.

Dbajte na svoju bezpečnosť.

1. Montáž domčeku vykonávajte na suchom mieste a za dobrých poveternostných podmienok
2. Domček montujte v 2-4 ľuďoch.
3. Pri montáži používajte ochranný odev, rukavice a ochranné okuliare.
4. V čase montáže by sa po stavenisku nemali pohybovať deti a domáce zvieratá.

Starostlivosť a údržba:

1. Dvere od domčeku nechávajú zatvorené a zamknuté, aby nedošlo k poškodeniu vplyvom vetra.
2. Domček čistite s pomocou handry a vody.
3. Vždy odstráňte opadané listy zo strechy čo najskôr, aby nedošlo k sfarbeniu strechy. Zo strechy pravidelne odstraňujte napadajúci sneh. Väčšia nános snehu na streche môže spôsobiť poškodenie strechy.
4. Domček nie je určený pre bývanie, ale pre ukladanie vecí. V záhradnom domčeku neskladujte horúce predmety, ako napr. Rozpálený gril, opaľovacie lampy, prchavé chemikálie a pod.

Slovenská verzia návodu je presným prekladom originálneho návodu výrobcu.

Fotografie použité v návode sú len ilustračné a nemusia sa presne zhodovať s výrobkom.



Köszönjük, hogy megvásárolta termékünket.

Használat előtt kérjük olvassa el a használati útmutatót.

Összeszerelési útmutató

Az összeszerelés megkezdése előtt alaposan olvassa el az összes utasítást és információt.

Győződjön meg róla, hogy rendelkezésére áll minden szükséges alkatrész a kerti ház összeszereléséhez.

A házat megfelelően rögzíteni kell az alapszerkezethez, hogy az erős szél ne tegyen kárt benne. Az alapszerkezetet a csomagolás nem tartalmazza, külön kell biztosítani.

Vigyázzon a biztonságára.

1. A kerti házat száraz helyen és jó időjárási körülmények között szerelje össze.
2. A ház összeszereléséhez 2-4 emberre van szükség.
3. Az összeszerelés során használjon védőruházatot, kesztyűt és védőszemüveget.
4. Az összeszereléskor gyermekek és háziállatok nem tartózkodhatnak a helyszínen.

Kezelés és karbantartás

1. A kerti ház ajtaját tartsa zárva, hogy elkerülje a szél okozta károkat.
2. A ház tisztításához használjon rongyot és vizet.
3. Mindig söpörje le a tetőről a ráhullott leveleket a lehető leghamarabb, hogy elkerülje a tető elszíneződését. Rendszeresen távolítsa el a ráhulló havat. A tetőre hullott nagyobb hó károsíthatja a kerti házat.
4. A ház nem alkalmas lakásnak, csak kellékek tárolására. Ne tároljon benne forró tárgyakat, mint pl. forró grill, gázégő, illékony vegyi anyagok stb.

A magyar használati utasítás a gyártótól kapott verzió pontos fordítása.

A kézikönyvben használt fényképek csak illusztrációk, nem egyeznek meg pontosan a termékkel.



Dziękujemy za zakup naszego produktu.

Przed użyciem prosimy starannie przeczytać tę instrukcję.

Instrukcja montażu:

Przed przystąpieniem do montażu należy dokładnie zapoznać się z wszystkimi zaleceniami i informacjami.

Sprawdź, czy posiadasz wszystkie niezbędne elementy do zbudowania altany ogrodowej.

Altana musi być prawidłowo zakotwiona do płyty fundamentowej, aby przy mocno wiejącym wietrze nie doszło do jej uszkodzenia lub zniszczenia. Płyta fundamentowa nie jest elementem zestawu, należy ją wykonać we własnym zakresie.

Dbaj o swoje bezpieczeństwo.

1. Montaż altany ogrodowej przeprowadzić w miejscu suchym i przy sprzyjających warunkach pogodowych.
2. Montaż altany ogrodowej przeprowadzać przy udziale 2-4 osób.
3. Przy montażu należy użyć odzieży ochronnej, rękawic i okularów ochronnych.
4. Podczas trwania montażu na placu budowy nie powinny przebywać dzieci i zwierzęta domowe.

Pielęgnacja i konserwacja:

1. Drzwi altany ogrodowej pozostawiać w stanie zamkniętym i zabezpieczonym zamkniętym zamkiem, aby uniknąć uszkodzeń spowodowanych na skutek działania wiatru.

2. Altanę ogrodową czyścić używając ścierek i wody.

3. Zawsze, jak najprędzej, należy usuwać opadłe liście z dachu, aby nie powodowały wystąpienia przebarwień na dachu. Z dachu należy regularnie usuwać śnieg. Grubsza warstwa okrywy śniegowej może spowodować uszkodzenie dachu.

4. Altana ogrodowa nie jest przeznaczona do zamieszkania, służy do przechowywania rzeczy. W altanie ogrodowej nie składować przedmiotów gorących, jak np. rozpalony grill, lampy do opalania, lotne chemikalia, itp.

Installation

Montage

Montáž

Összeszerelés

Montaż



Tools you will need / Werkzeuge, die Sie brauchen / Nástroje, které budete potřebovat
 Nástroje, ktoré budete potrebovať / Szükséges eszközök és szerszámok / Przyrządy
 i narzędzia, które będą potrzebne

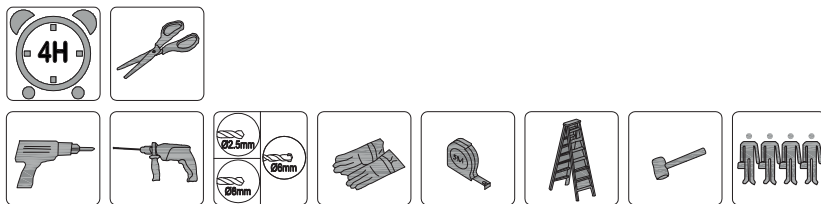

Dimensions \ Abmessungen \ Rozměry \ Rozmery \ Méretek \ Wymiary

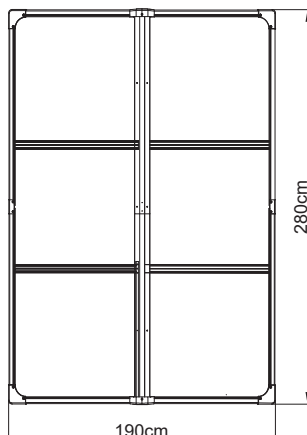
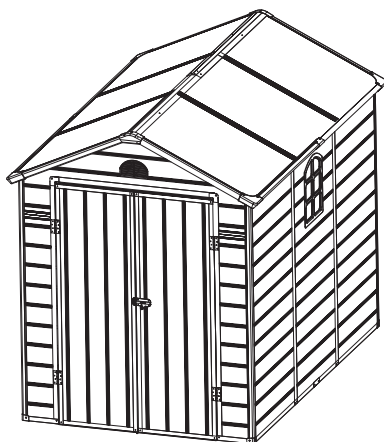
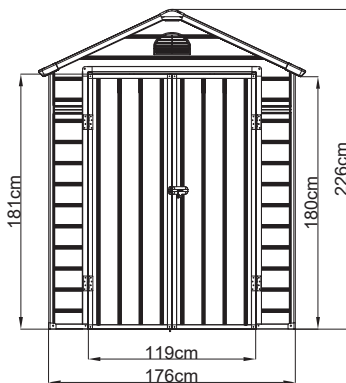
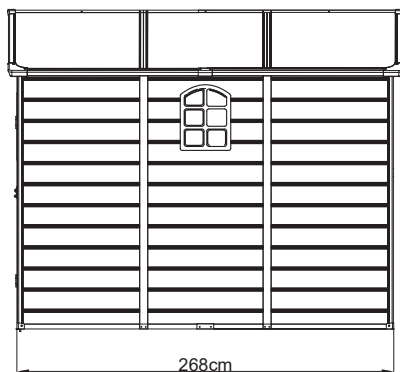

Parts list \ Teilleiste \ Seznam dílů \ Zoznam dielov \ Alkatrész lista \ Wykaz części

VA-C1		1735mm	x1	3/3
VA-E2R		1330mm	x2	3/3
VA-E2L		1330mm	x2	3/3
VA-C3R		267mm	x1	3/3
VA-C3L		267mm	x1	3/3
VA-E2M		120mm	x2	3/3
VA-C4		1278mm	x1	3/3
VA-30			x4	2/3
VA-31			x4	2/3
VA-37			x6	2/3
PB1		876x1840mm	x5	1/3
PB1S		876x1840mm	x1	1/3
PB2B		1710x676mm	x1	1/3
PB3L		566x990mm	x1	1/3
PB3R		566x990mm	x1	1/3
PB3S		566x1125mm	x1	2/3
PB4		566x1100mm	x3	2/3
PB5		255x1548mm	x2	1/3
VA-C7R		1860mm	x2	3/3
VA-C7L		1860mm	x2	3/3
VA-C5		1840mm	x6	3/3
VA-C5b		285mm	x2	3/3
VA-C6b		200mm	x2	3/3
PPX12			x1	1/3
W2S			x1	1/3
PPX13			x1	1/3
VA-C8		562mm	x3	1/3
VA-C9		250mm	x2	1/3
VA-C11		562mm	x3	3/3
VA-C12		250mm	x2	3/3
VA-E17		977mm	x2	3/3
VA-E18		1745mm	x2	3/3
VA-D19		888mm	x4	3/3
VA-D20		725mm	x2	3/3
VA-33			x4	3/3
VA-34			x2	3/3
VA-E23		1348mm	x2	3/3
VA-36			x2	2/3
VA-32R			x2	2/3
VA-32L			x2	2/3
VA-35			x2	2/3
PPX14			x2	2/3
PPX8			x2	2/3
PPX9			x2	2/3

PB6-C		990x920mm	x4	2/3
PB6-M		990x856mm	x2	2/3
VA-E10		990mm	x4	1/3
VA-E13		990mm	x4	3/3
VA-D21		870mm	x4	2/3
VA-E22		1282mm	x4	3/3
VA-E24		1440mm	x2	3/3
VA-E41		983mm	x2	3/3
VA-F42		1862mm	x2	3/3
PPX3			x4	2/3
PPX4			x2	2/3
PPX11			x2	2/3
VA-C25R		1830mm	x1	3/3
VA-C25L		1830mm	x1	3/3
VA-C26		1198mm	x1	3/3
VA-C27		1812mm	x3	3/3
VA-C28		592mm	x4	3/3
VA-C29		1812mm	x1	3/3
PB7S		1810x591mm	x2	1/3
VA-41			x4	2/3
VA-38a			x2	2/3
VA-38b			x2	2/3
VA-39			x2	2/3
VA-40			x1	2/3
CN-A33			x2	2/3
PA01			x3	2/3
VA-E44		ST4.2x13mm	x298	2/3
VA-E45		ST4.2x19mm	x111	2/3
VA-E46		ST4.2x13mm	x36	2/3
VA-E47		ST4.2x19mm	x4	2/3
VA-E48		ST6.0x40mm	x15	2/3
VA-E49		ST4.2x13mm	x8	2/3
VA-E50		M6x40mm	x20	2/3
VA-51			x1	2/3
VA-E52			x2	2/3
VA-53			x2	2/3

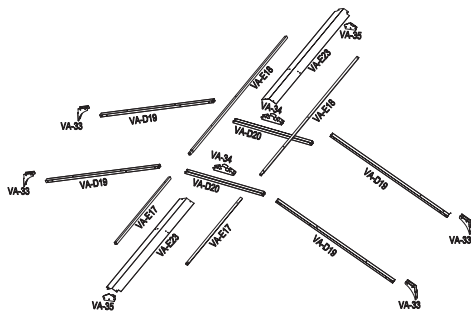
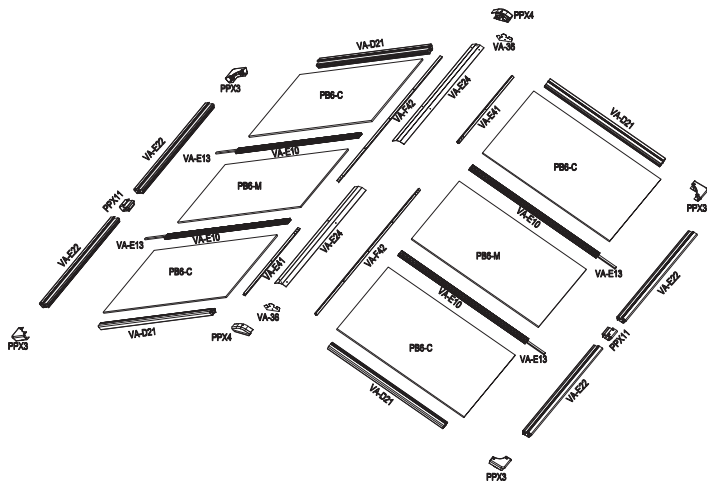

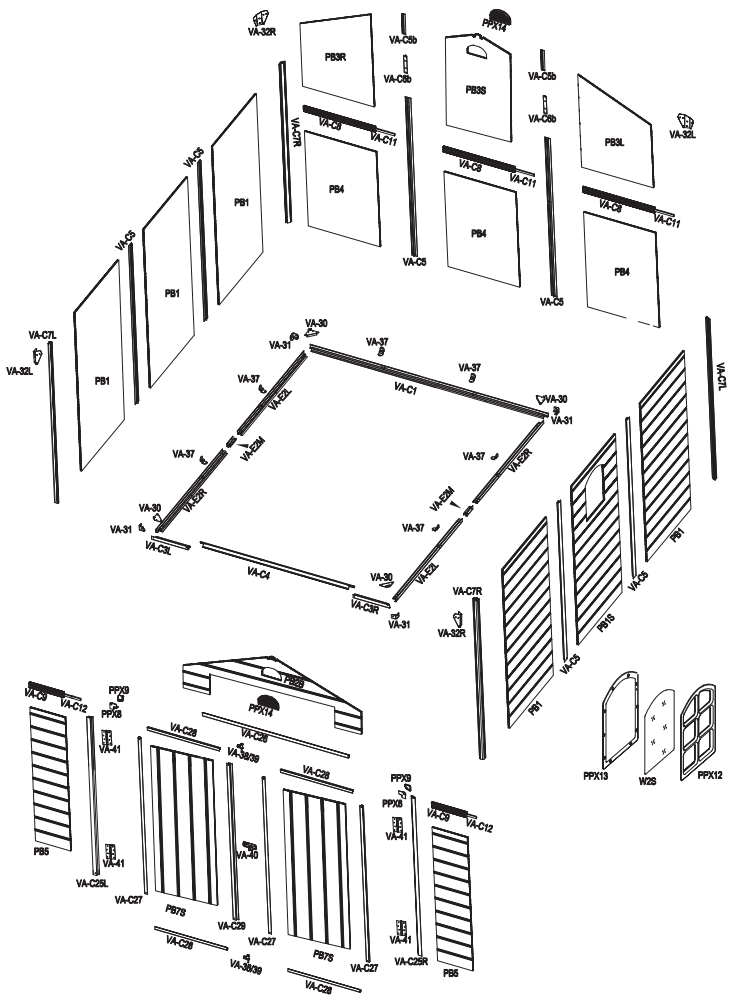



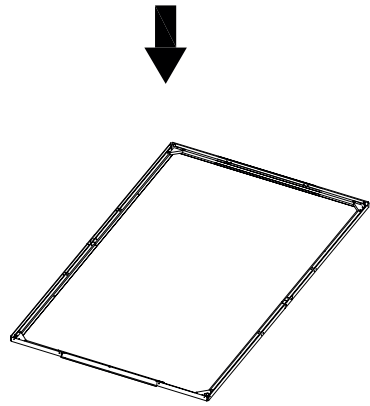
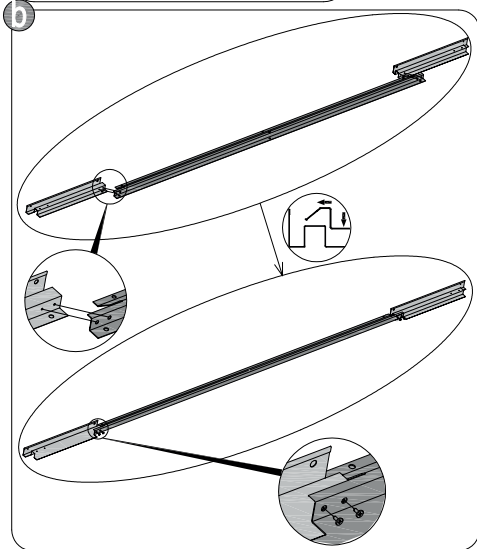
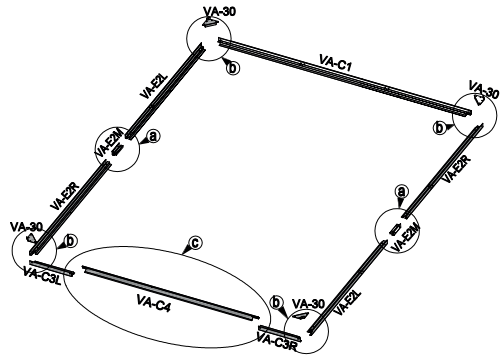
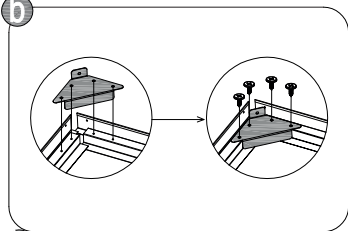
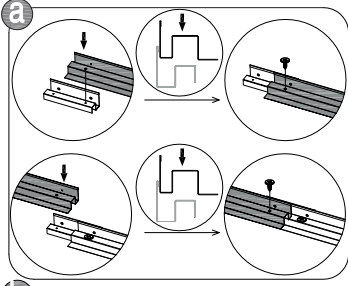

1	VA-E2L [x4] 1330mm	VA-E2R [x4] 1330mm	VA-C1 [x1] 1736mm	VA-C3L [x1] 267mm	VA-C3R [x1] 267mm	VA-C4 [x1] 1279mm	VA-E2M [x4] 120mm	VA-30 [x4]	VA-E44 [x4] 13mm
----------	-----------------------	-----------------------	----------------------	----------------------	----------------------	----------------------	----------------------	------------	---------------------

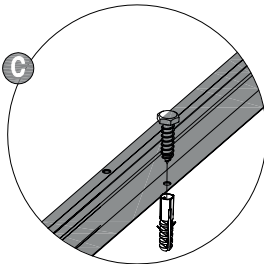
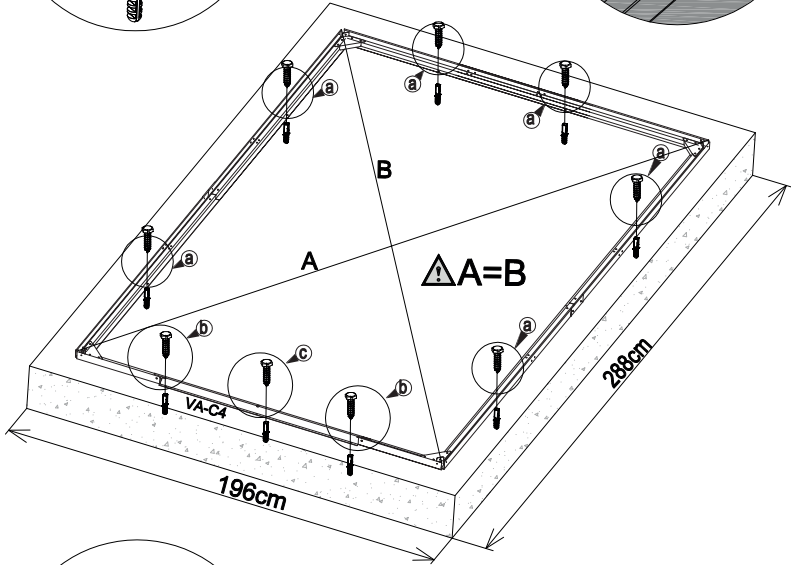
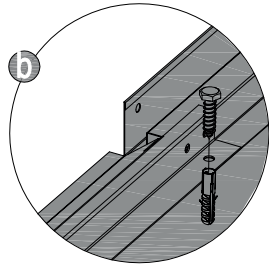
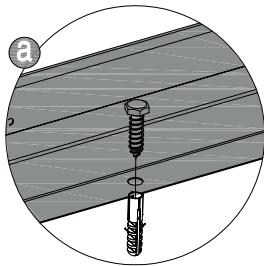

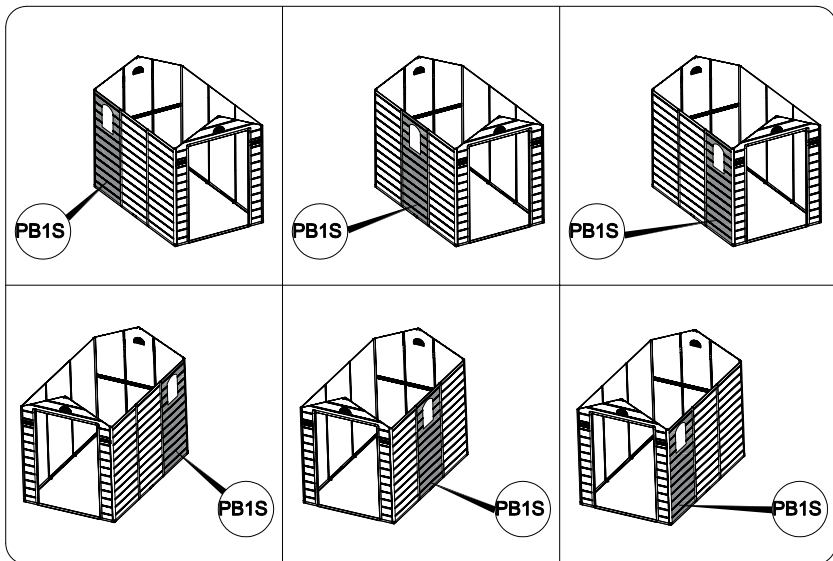



2 VA-E46 pólj 40mm



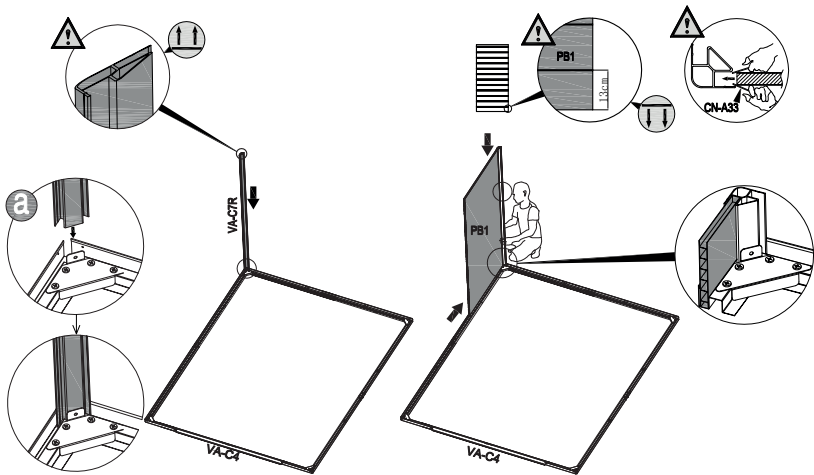

<p>3</p>	<p>PB1 (x1) 676x1940mm</p> 	<p>VA-C7R (x1) 1900mm</p> 	<p>CN-A33</p> 	
-----------------	--	---	---	---



4	 PB4 [x1] 590x1100mm	 VA-E45 [x9] 19mm	 CN-A33	
----------	---	--	---	---



1.3cm



CN-A33





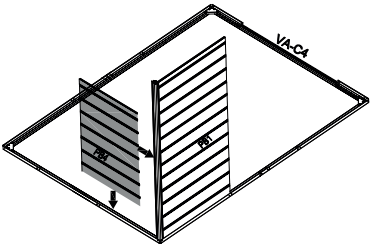

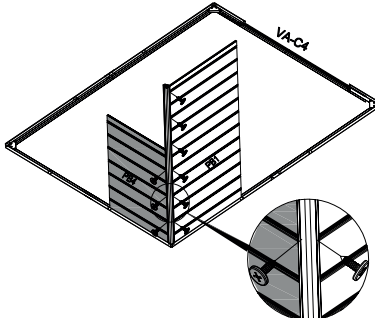

VA-E45



VA-C4



VA-C4

5	 VA-C7L [x1] 1880mm	 PB1 [x1] 870x1640mm	 PB4 [x1] 590x1100mm	 VA-E45 [x9] 19mm	 CN-A33	
----------	--	---	---	--	---	---



1.3cm



1.3cm



1.3cm



VA-E45

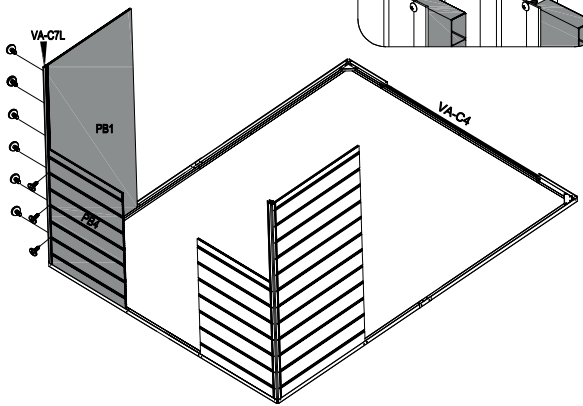



VA-C7L





PB1

PB4

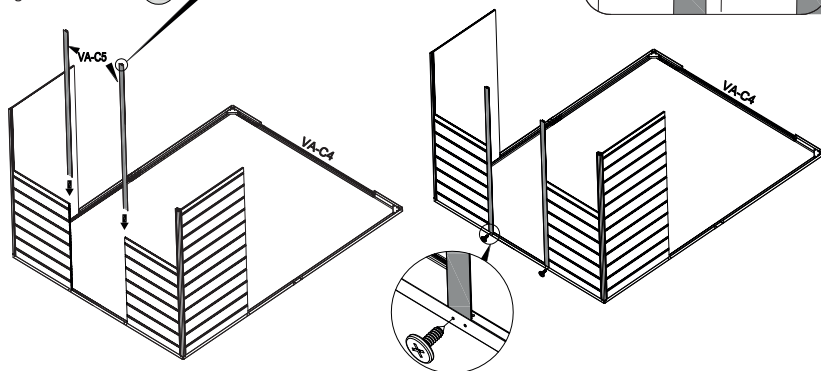
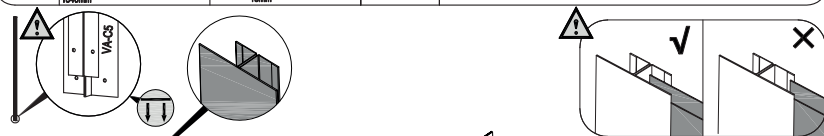
VA-C4

6	 VA-C5 [x2] 1940mm	 VA-E44 [x2] 13mm	 CN-A33	
----------	---	--	---	--





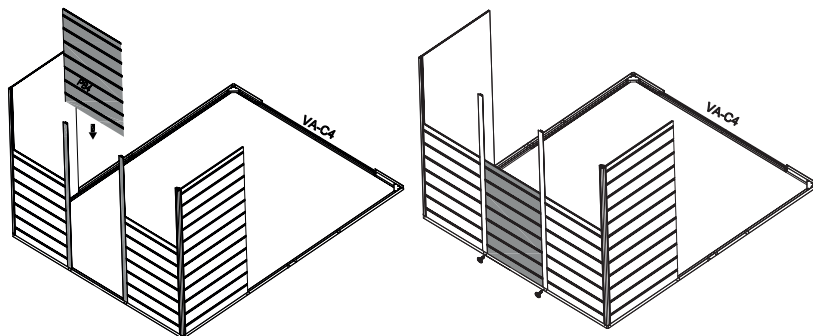
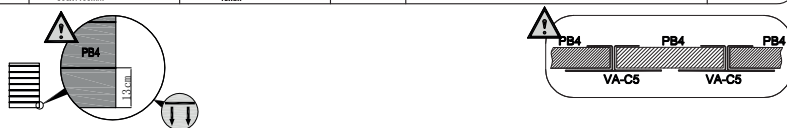

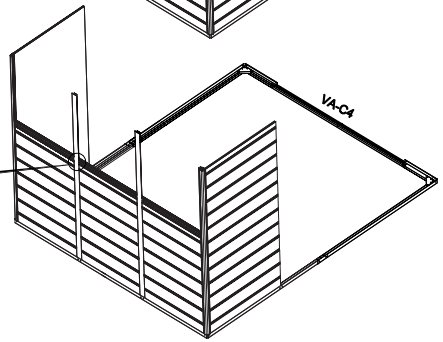
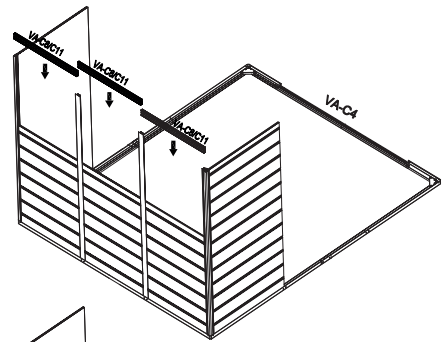
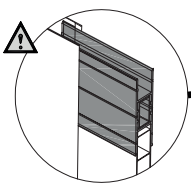
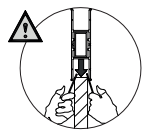
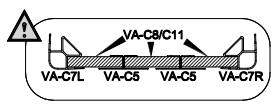
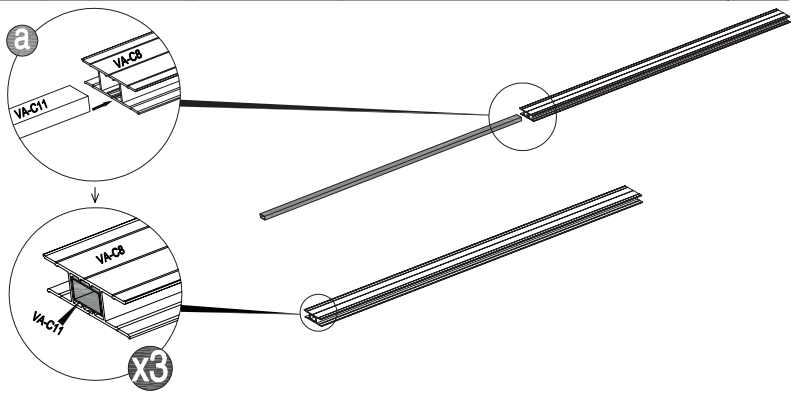

7	 PB4 [x1] 595x1100mm	 VA-E44 [x2] 13mm	 CN-A33	
----------	---	--	---	---

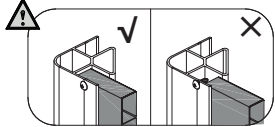
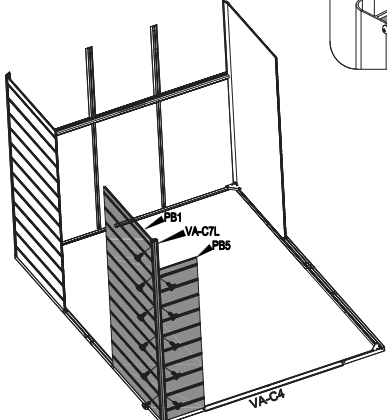
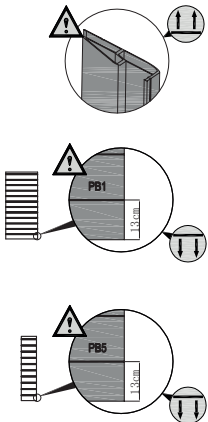

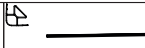

9						



10						

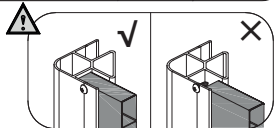
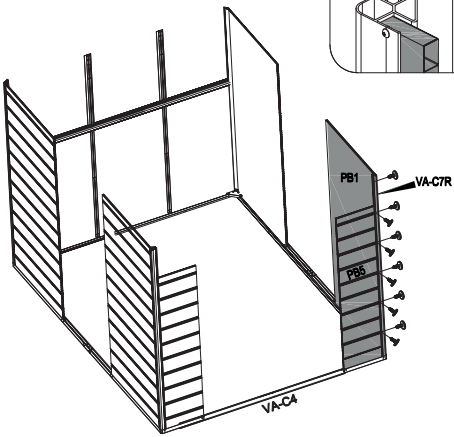
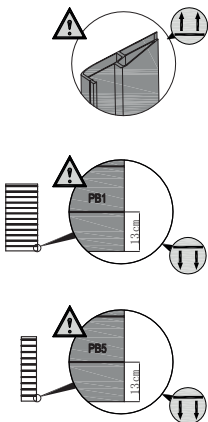

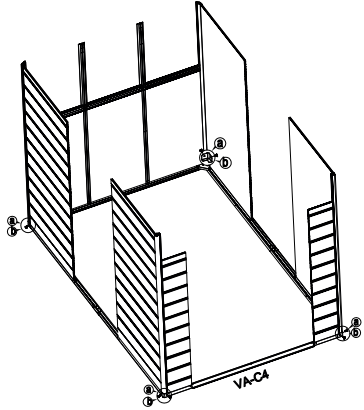
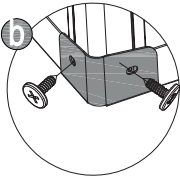
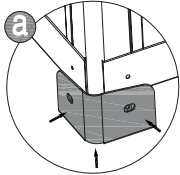

	<p>VA-31 [x4]</p>	<p>VA-E44 [x4] 13mm</p>	
--	-------------------	-----------------------------	--



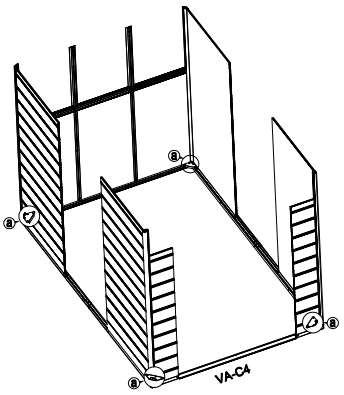
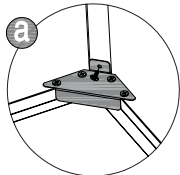



	<p>VA-E44 [x4] 13mm</p>	
--	-----------------------------	--

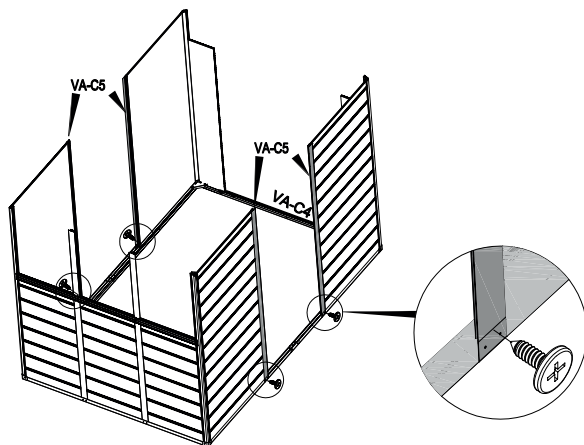
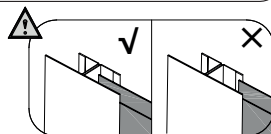
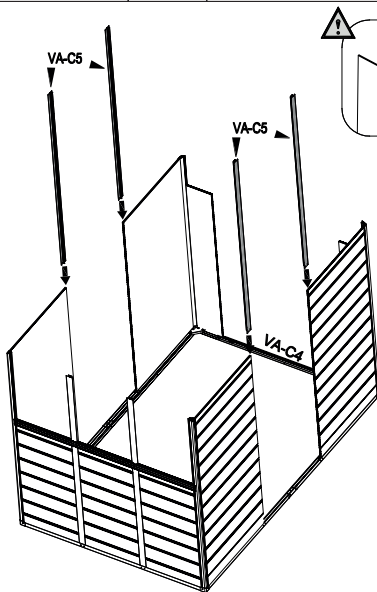
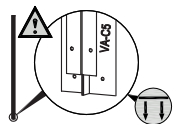





13	 VA-C5 [m] 1840mm	 VA-E44 [m] 13mm	 CN-A33	
-----------	--	---	---	--

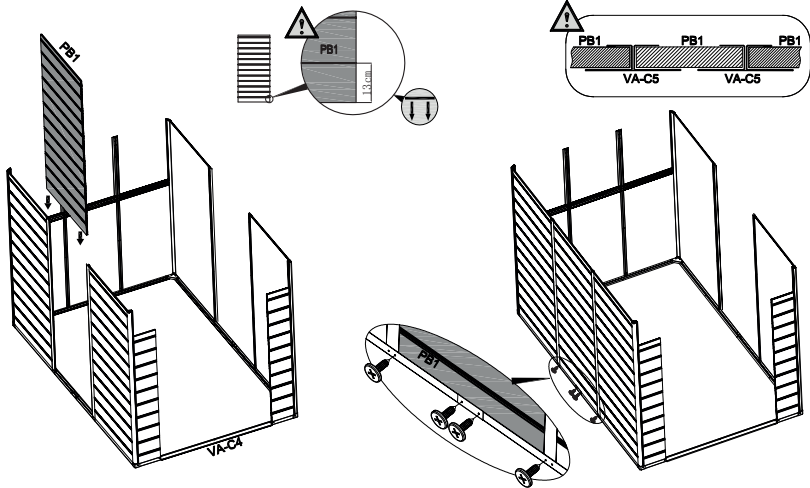





14	 PB1 [x1] 87x1640mm	 VA-E44 [x4] 13mm	 CN-A33	
-----------	---	---	--	---

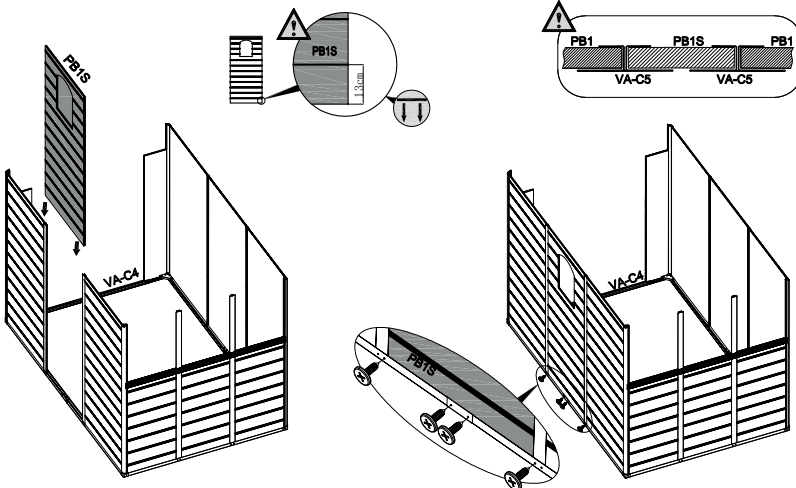

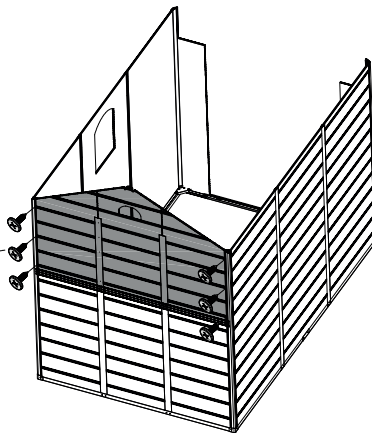
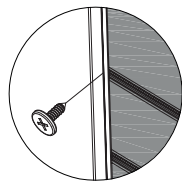
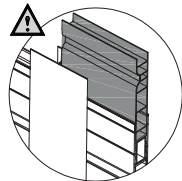
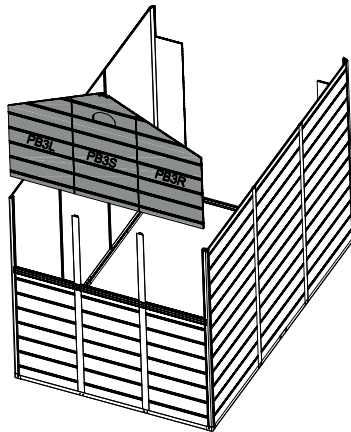
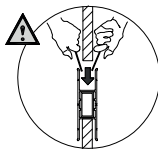
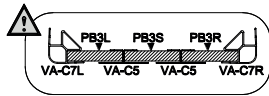
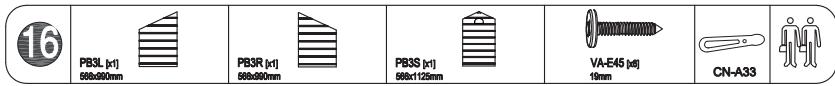

15	 PB1S [x1] 87x1640mm	 VA-E44 [x4] 13mm	 CN-A33	
-----------	--	---	--	---



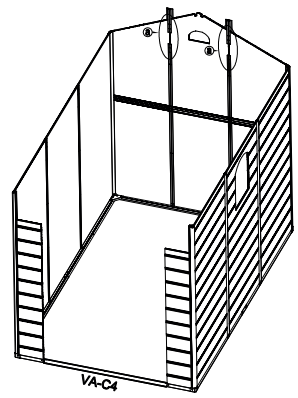
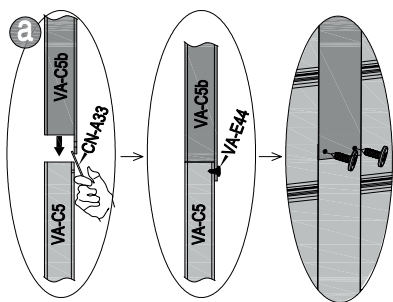
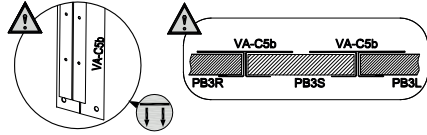

17	 VA-C5b (x2) 280mm	 VA-E44 (x4) 13mm	 CN-A33
-----------	---	--	---



18	 VA-C8b (x2) 200mm	 VA-E44 (x16) 13mm	
-----------	---	---	--

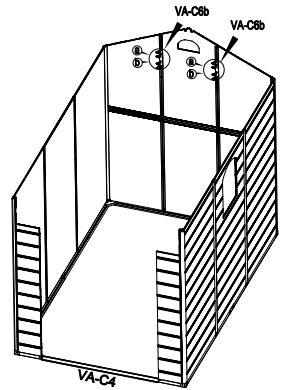
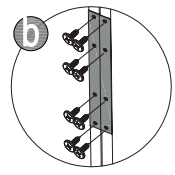
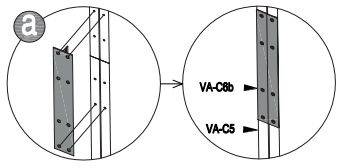

19	 VA-C9 [x2] 25mm	 VA-C12 [x2] 25mm	 CN-A33	
-----------	---	--	---	---

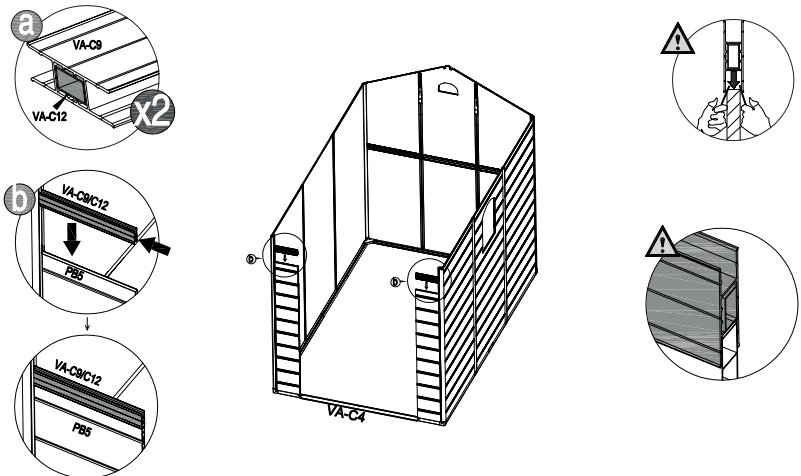

a

b





VA-C9

VA-C12

VA-C9/C12

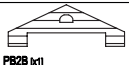
PBS

VA-C4

20	 PB28 [x1] 171x67mm	 VA-E45 [x2] 10mm	 CN-A33		
-----------	--	--	---	---	---

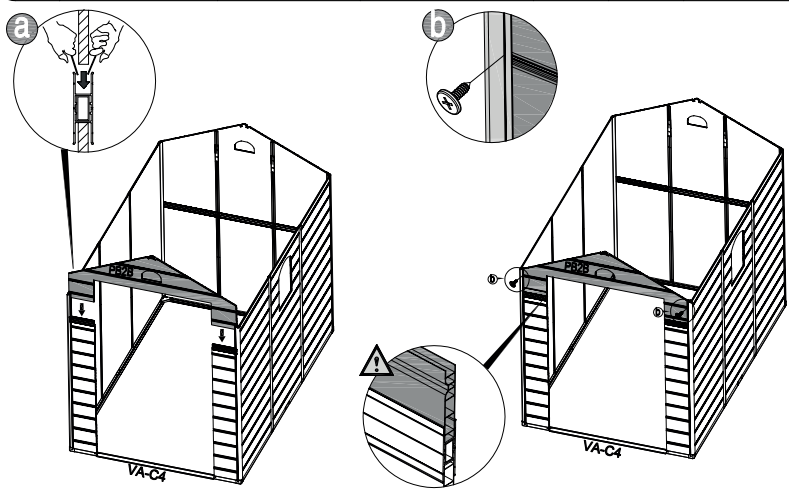

a

b





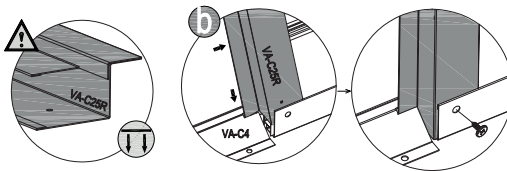
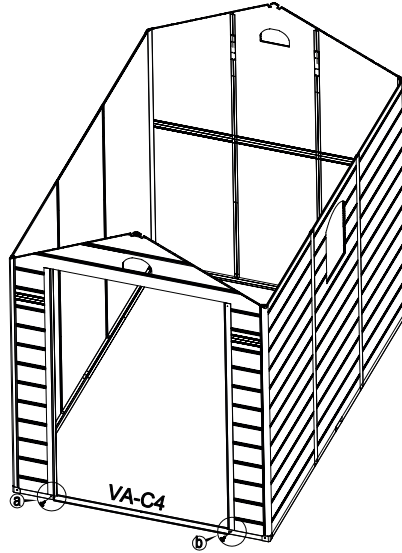
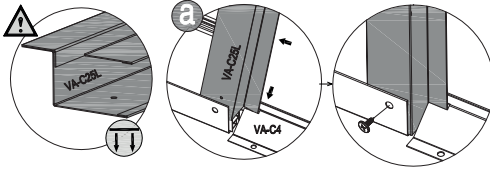

PB28

VA-E45

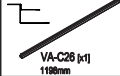
VA-C4

<p>21</p>	 <p>VA-C25L (x1) 1830mm</p>	 <p>VA-C25R (x1) 1830mm</p>	 <p>VA-E44 (x2) 13mm</p>	
------------------	--	--	---	--



22	 VA-C26 (x1) 118mm	 PPX8 (x2)	 PPX9 (x2)	 VA-E44 (x4) 13mm	 VA-E46 (x4) 13mm	 VA-E47 (x4) 13mm
-----------	---	--	--	--	--	--

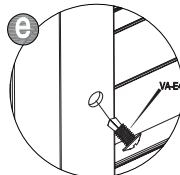
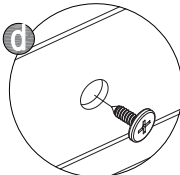
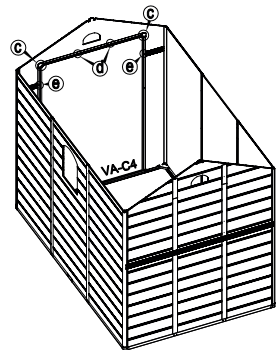
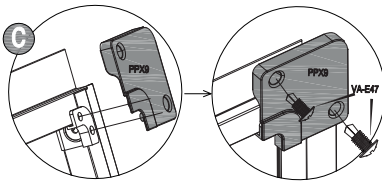
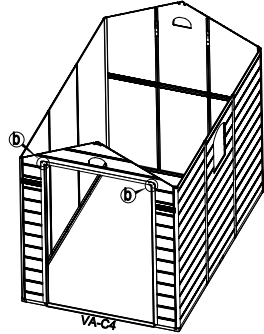
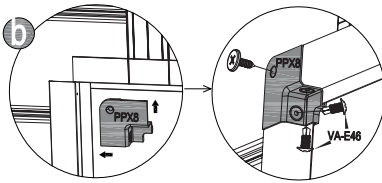
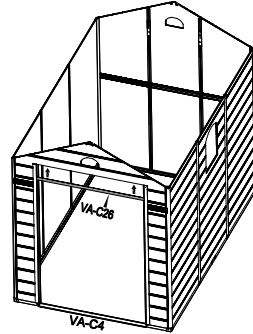
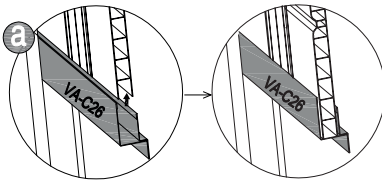

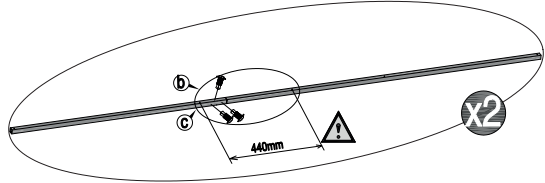
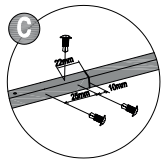
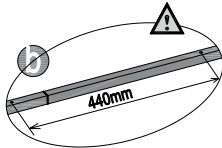
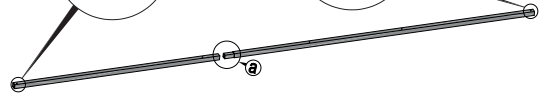
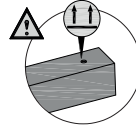
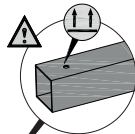
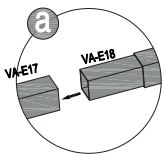
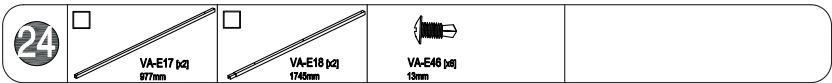
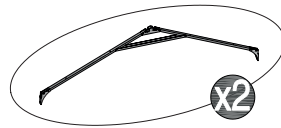
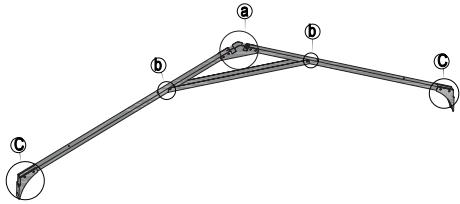
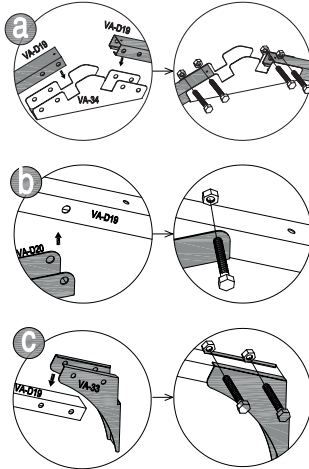
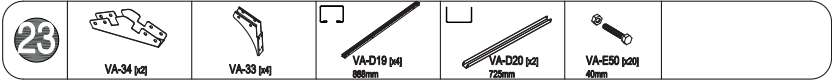



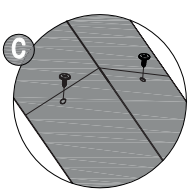
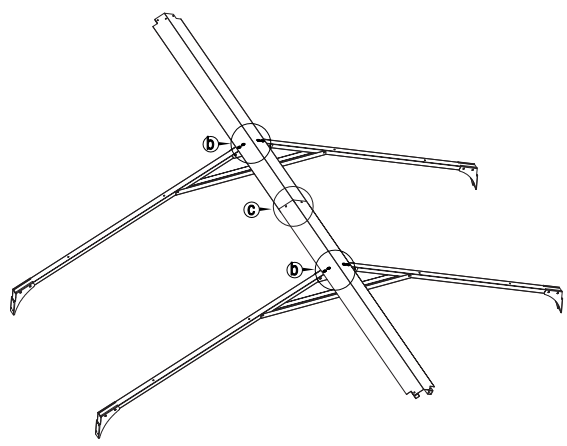
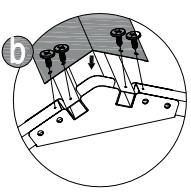
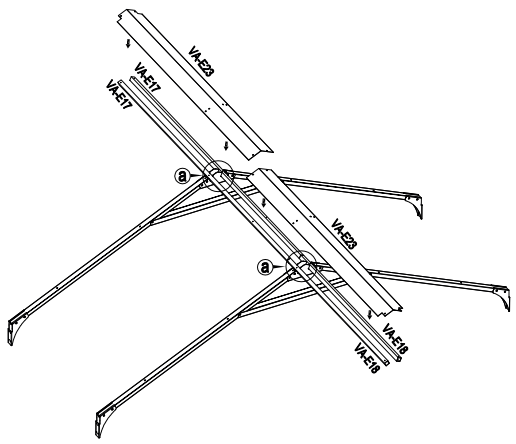
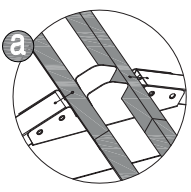

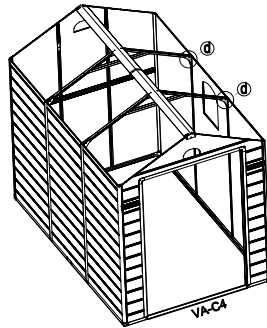
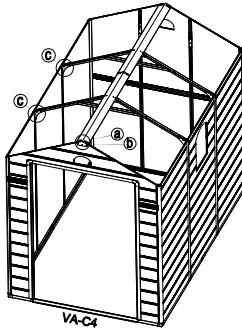
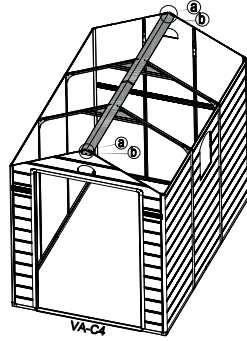
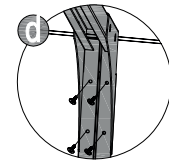
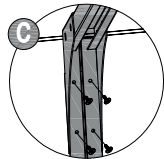
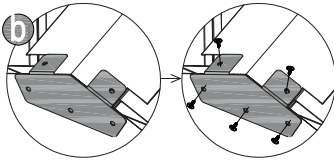
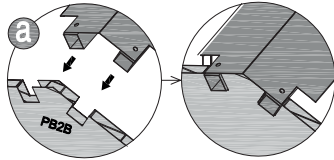

25	 <p>VA-E23 (x2) 1350mm</p>	 <p>VA-E44 (x10) 13mm</p>	
-----------	---	--	--



26	 VA-35 [2]	 VA-E44 [2x] 13mm		
----	--	--	---	---



<p>27</p>	 <p>PB6-M [x2] 960x500mm</p>	 <p>PB6-C [x4] 960x500mm</p>	 <p>VA-E10 [x4] 950mm</p>	 <p>VA-E13 [x4] 950mm</p>	 <p>VA-E44 [x24] 15mm</p>	 <p>CN-A33</p>
-----------	---	---	--	--	--	---

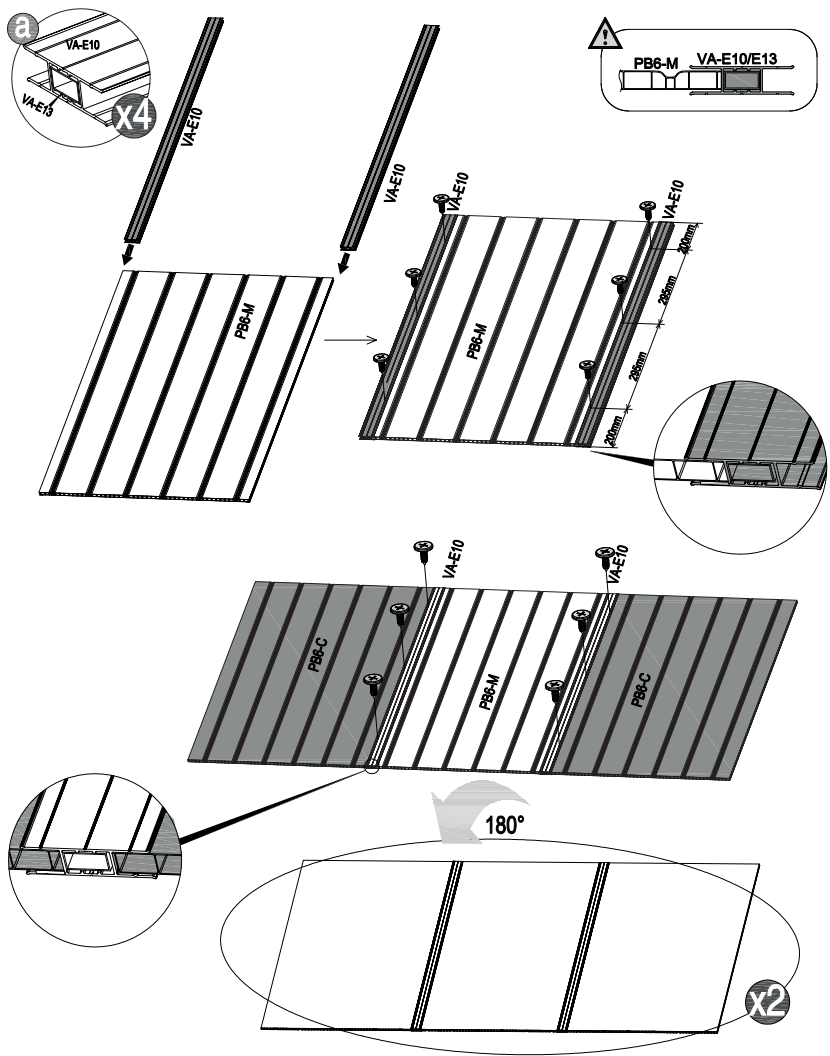

28	 VA-53 [x2]	 VA-E44 [x18] 13mm	 CN-A33
-----------	---	---	---

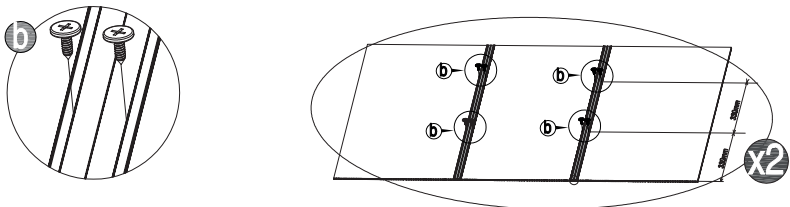
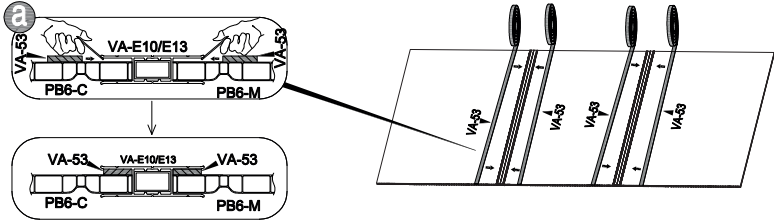



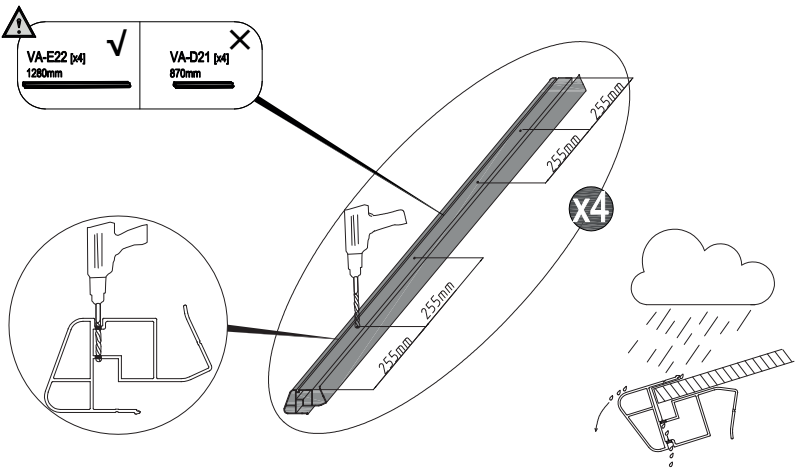

29	 VA-E22 [x4] 1280mm	 Ø8mm		
-----------	--	---	--	--

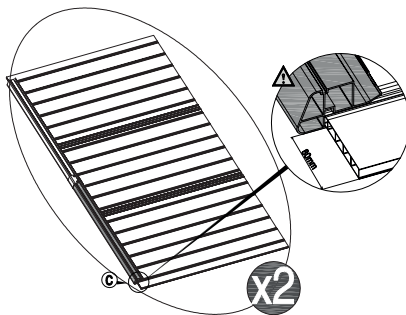
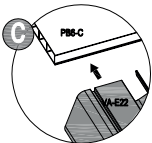
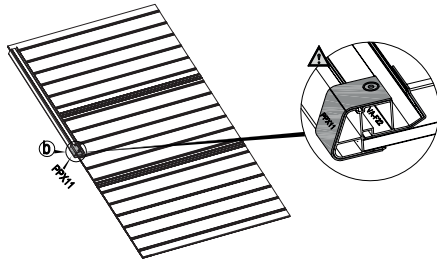
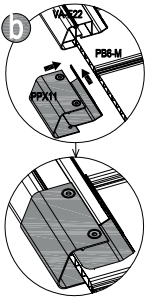
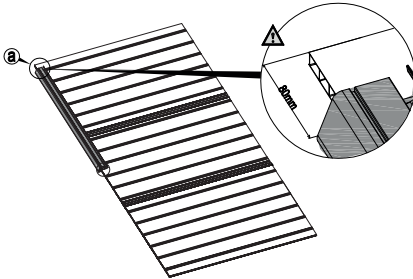
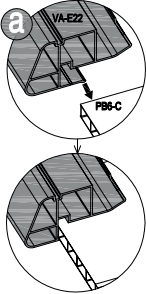





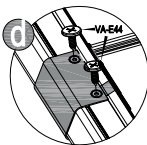
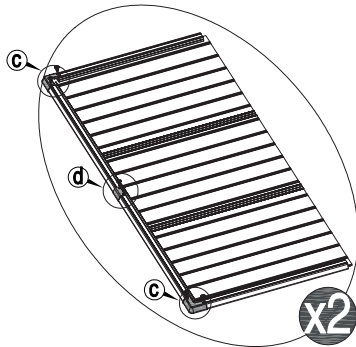
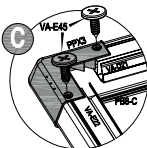
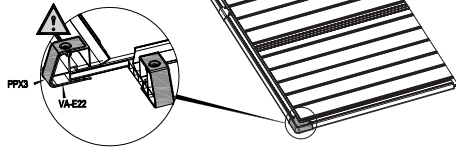
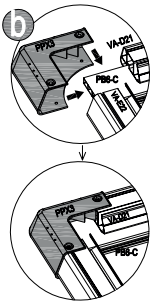
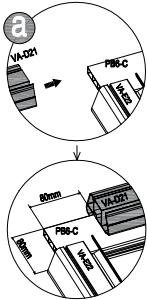

	<p>VA-E22 (x4) 120mm</p>	<p>PPX11 (x2)</p>	<p>CN-A33</p>
--	------------------------------	-------------------	---------------



<p>31</p>	 <p>VA-D21 [x4] 870mm</p>	 <p>PPX3 [x4]</p>	 <p>VA-E44 [x4] 13mm</p>	 <p>VA-E45 [x4] 19mm</p>		 <p>CN-A33</p>
------------------	--	--	---	---	--	---



32	 VA-F42 [x2] 182mm	 VA-E41 [x2] 83mm	 VA-E45 [x2] 18mm	 VA-E46 [x8] 13mm	 VA-E44 [x12] 13mm	 CN-A33
-----------	--	---	---	---	--	--

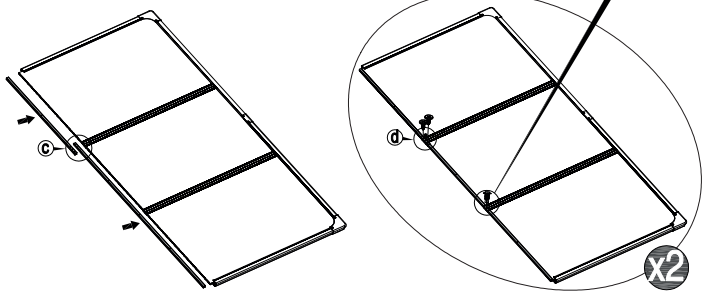
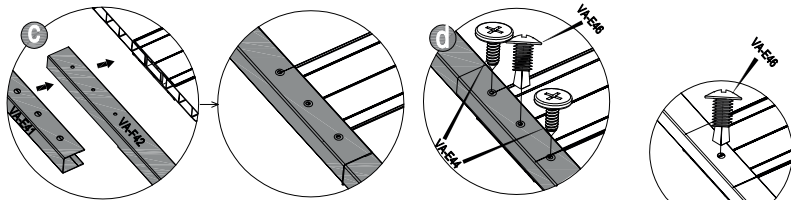
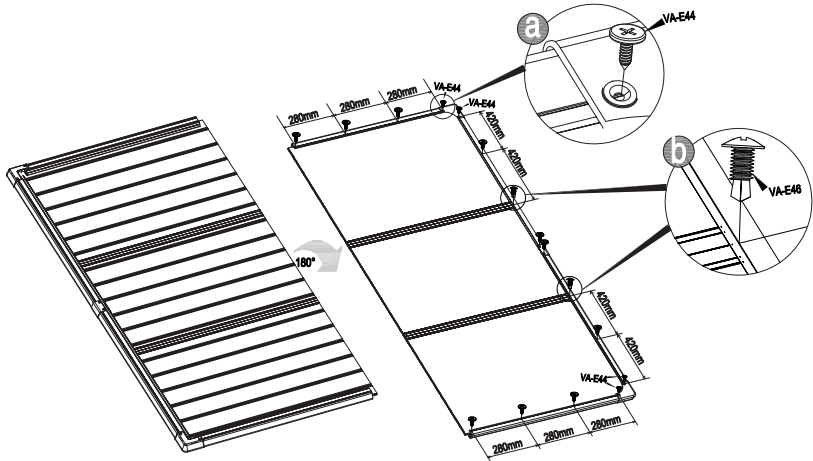

	 CN-A33		
--	------------	--	--

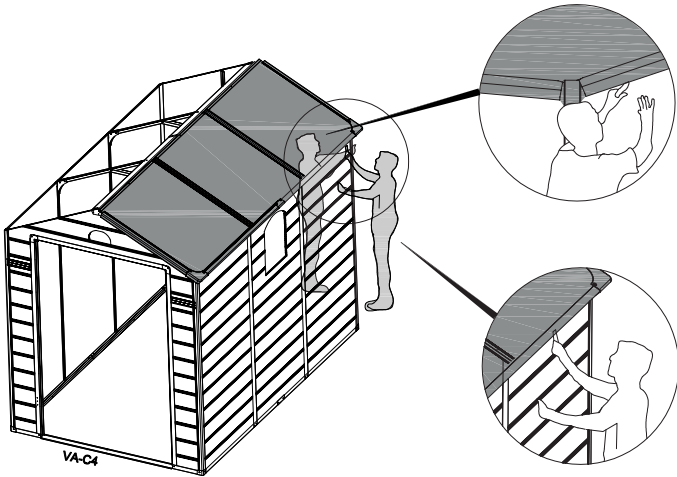
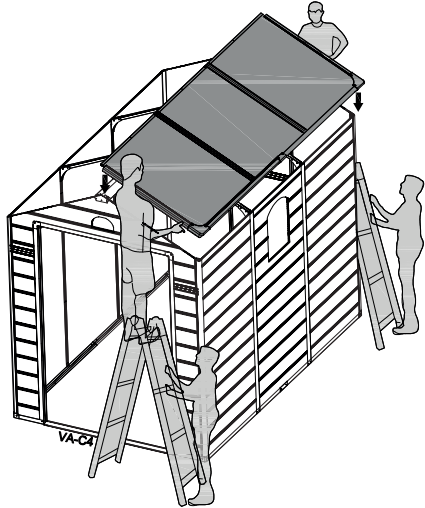
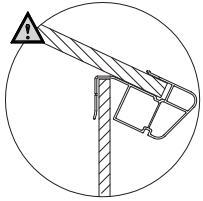
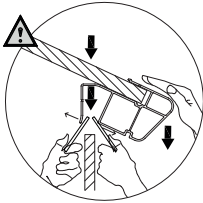

34





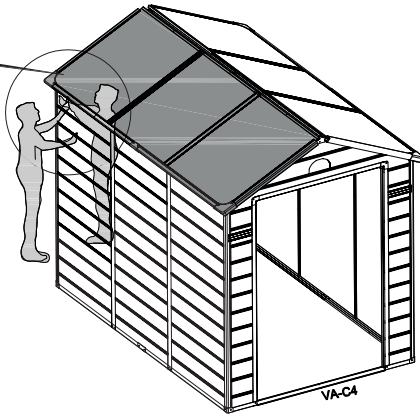
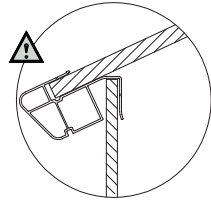
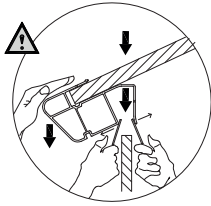

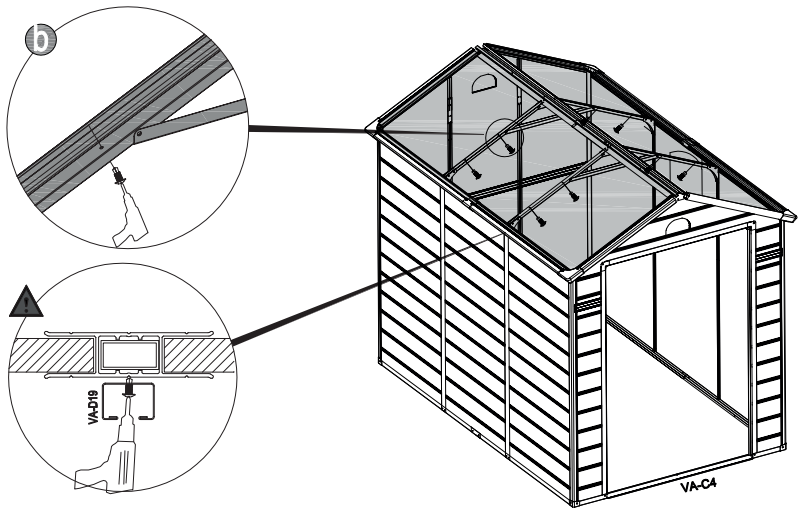
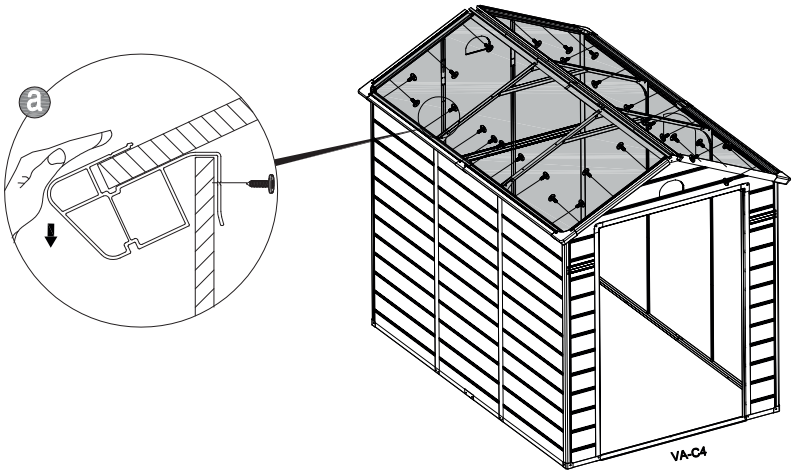

CN-A33







	 VA-E45 [p28] 18mm	 VA-E46 [p28] 13mm	
---	---	---	--

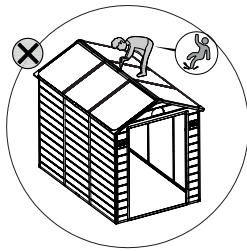
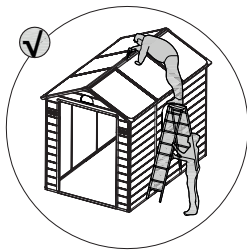
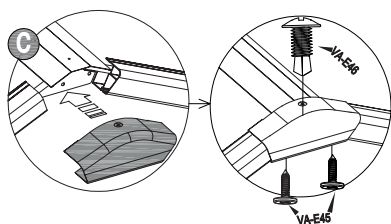
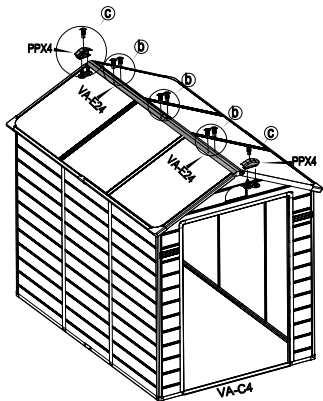
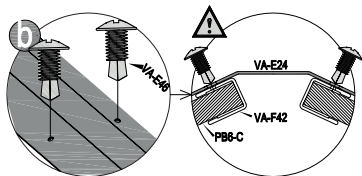
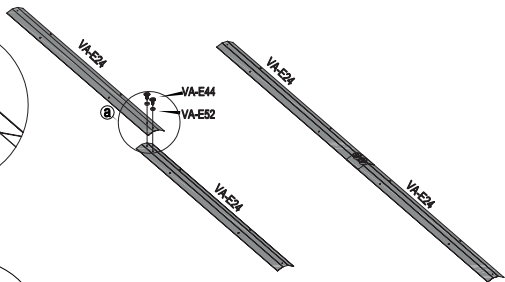
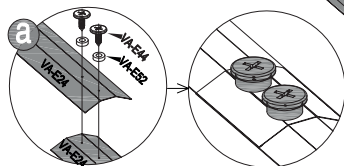

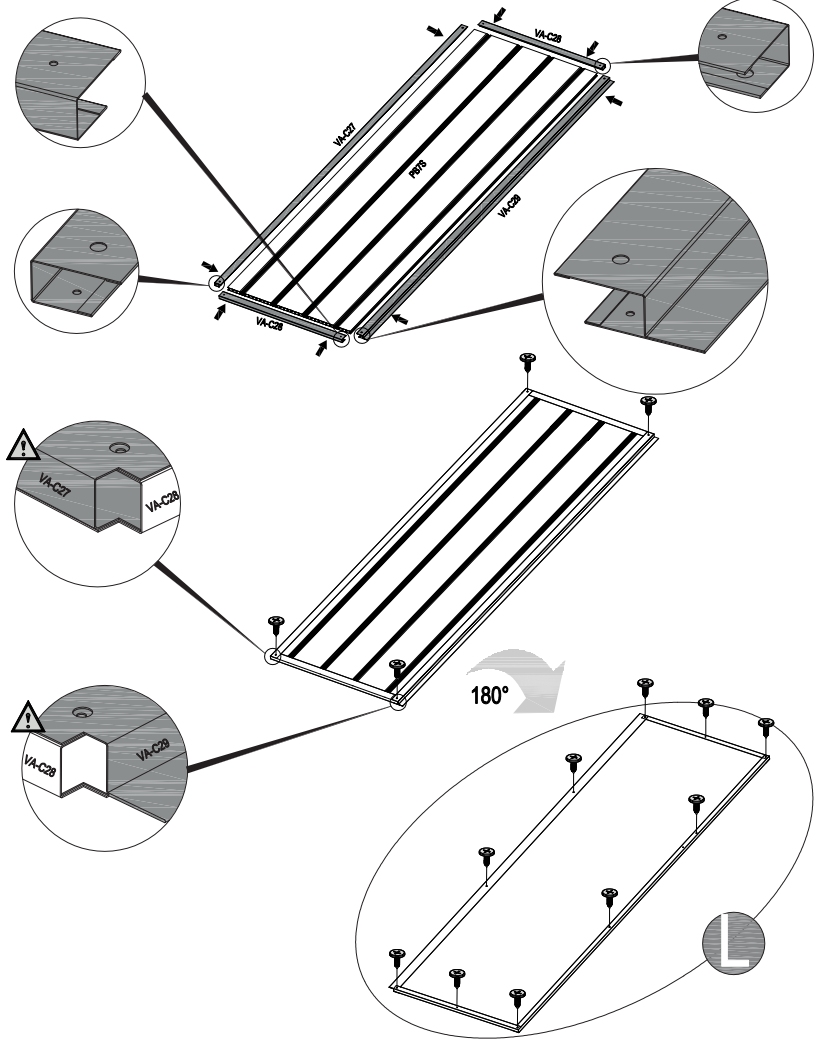
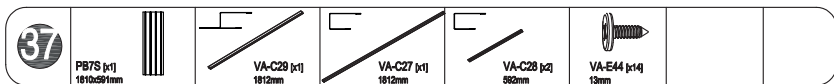

36	 VA-E24 (x2) 140mm	 PPX4 (x2)	 VA-E44 (x2) 13mm	 VA-E45 (x4) 13mm	 VA-E46 (x8) 13mm	 VA-E52 (x2)
-----------	--	---	---	---	---	---

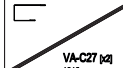

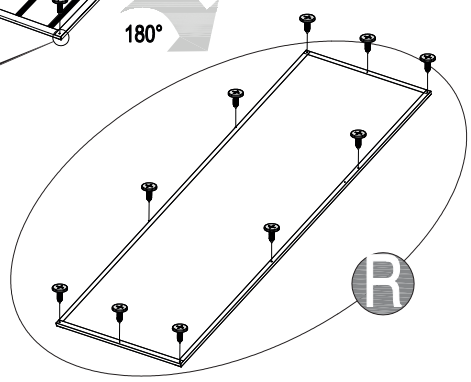
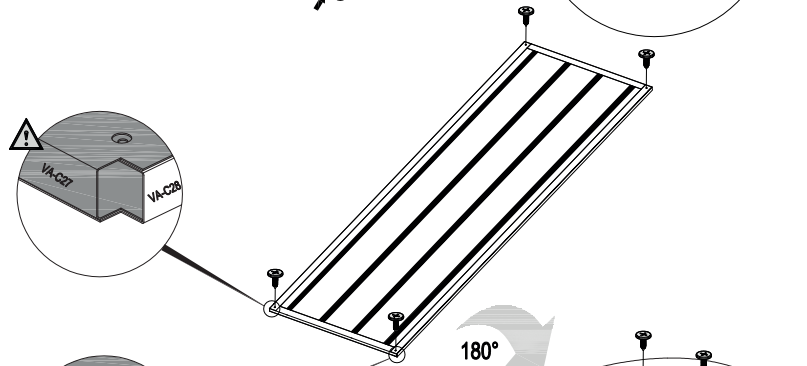
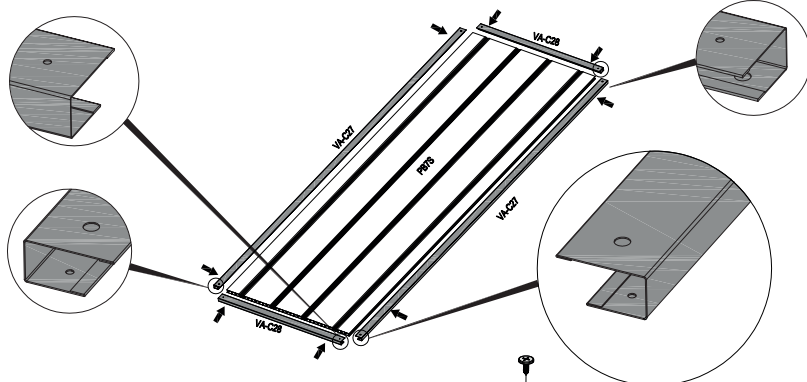

38	 PB75 [x1] 1810x591mm	 VA-C27 [x2] 1812mm	 VA-C28 [x2] 892mm	 VA-E44 [x14] 13mm			
-----------	--	--	---	---	--	--	--



<p>39</p>	 <p>VA-41 [p4]</p>	 <p>VA-40 [p1]</p>	 <p>PAD1 [p3]</p>	 <p>VA-E45 [p2] 18mm</p>	 <p>VA-E44 [p2] 13mm</p>	 <p>Ø2.5mm</p>
-----------	---	---	--	---	---	---

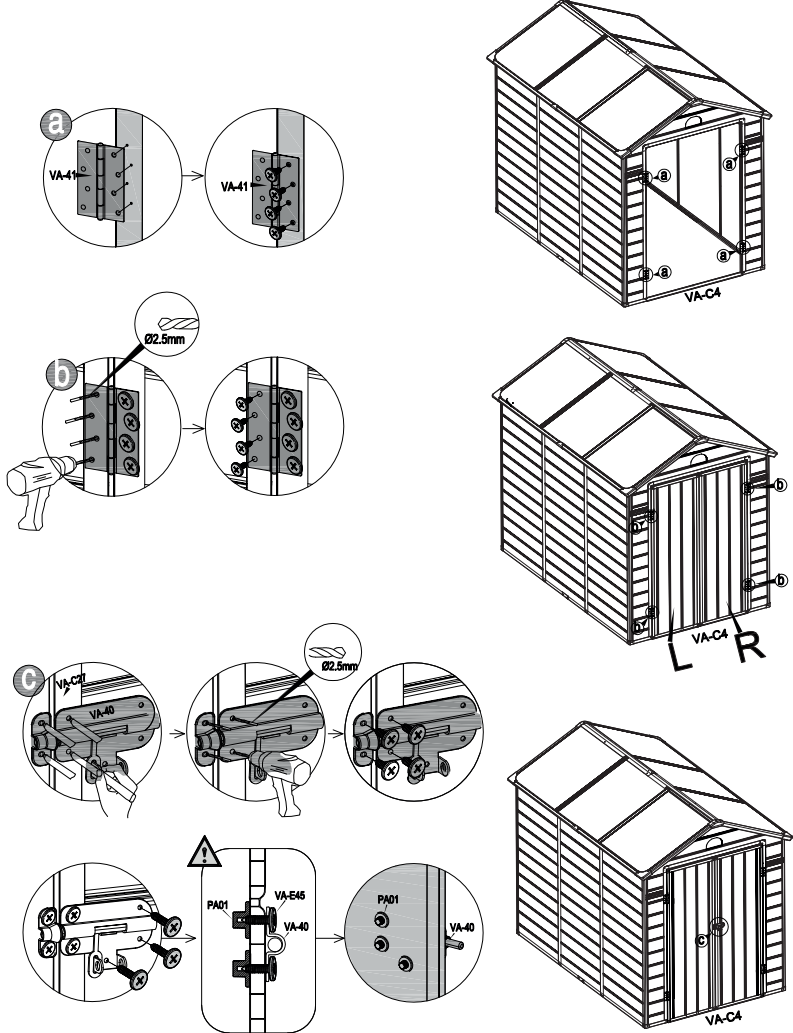

40	VA-38a [x2]	VA-38b [x2]	VA-39 [x2]	VA-E49 [x4] 13mm	Ø2.5mm	
-----------	-------------	-------------	------------	---------------------	--------	--

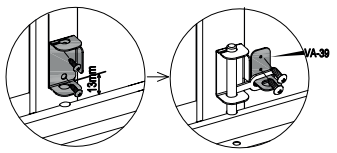
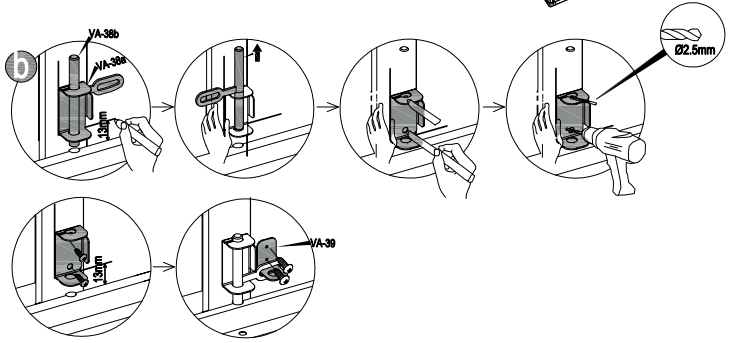
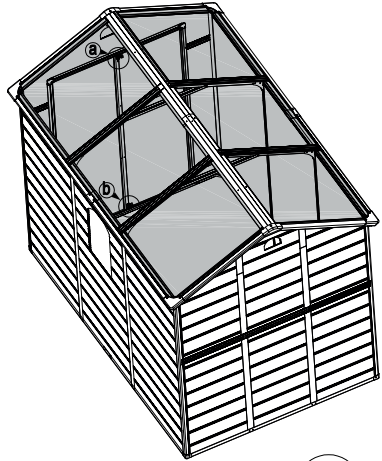
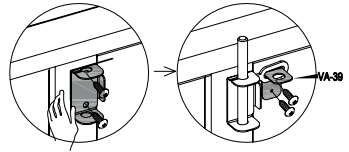
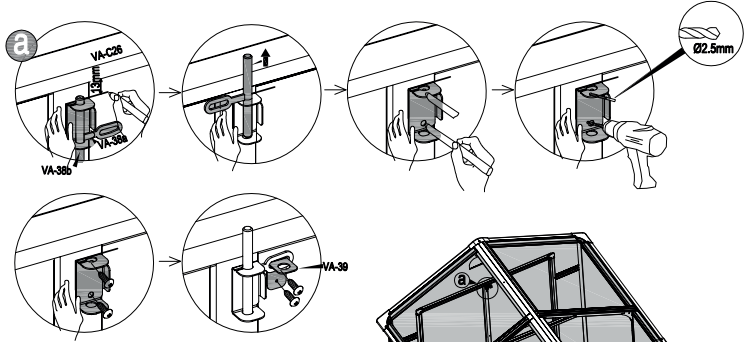

41	 VA-36 [x2]	 VA-32L [x2]	 VA-32R [x2]	 VA-37 [x2]	 VA-E44 [x2] 13mm	 VA-E48 [x2]
-----------	----------------	-----------------	-----------------	----------------	-------------------------	-----------------

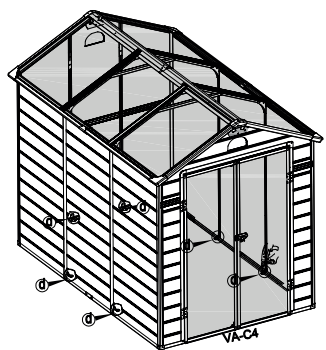
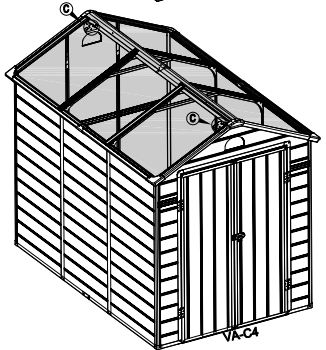
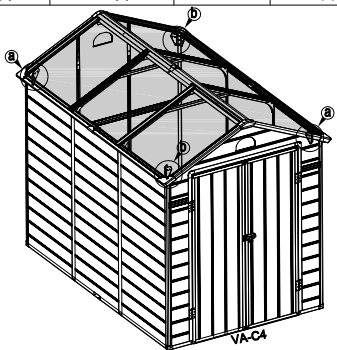
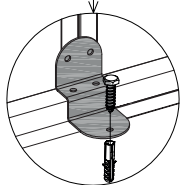
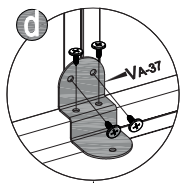
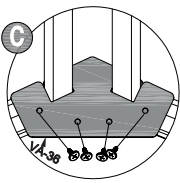
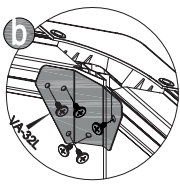
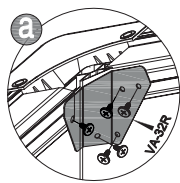

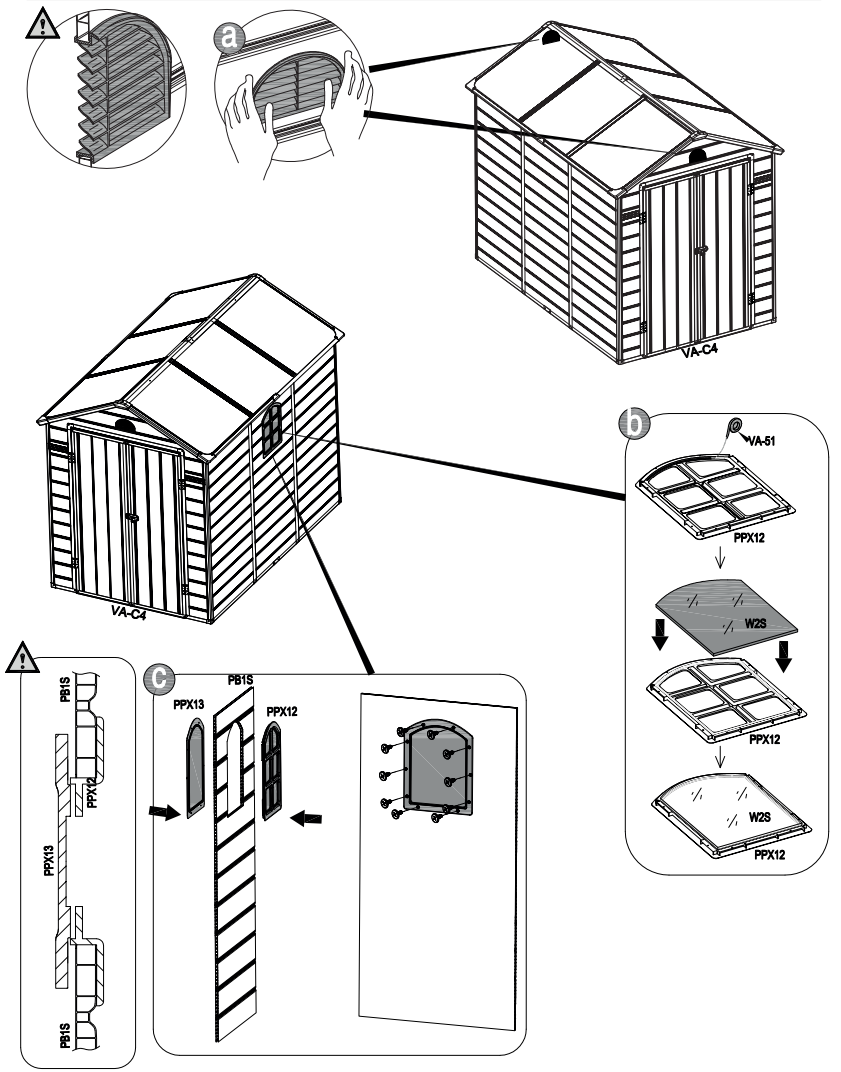
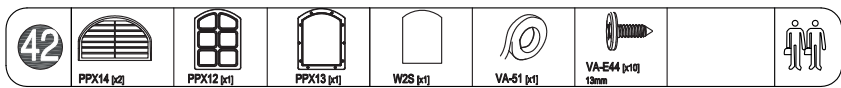

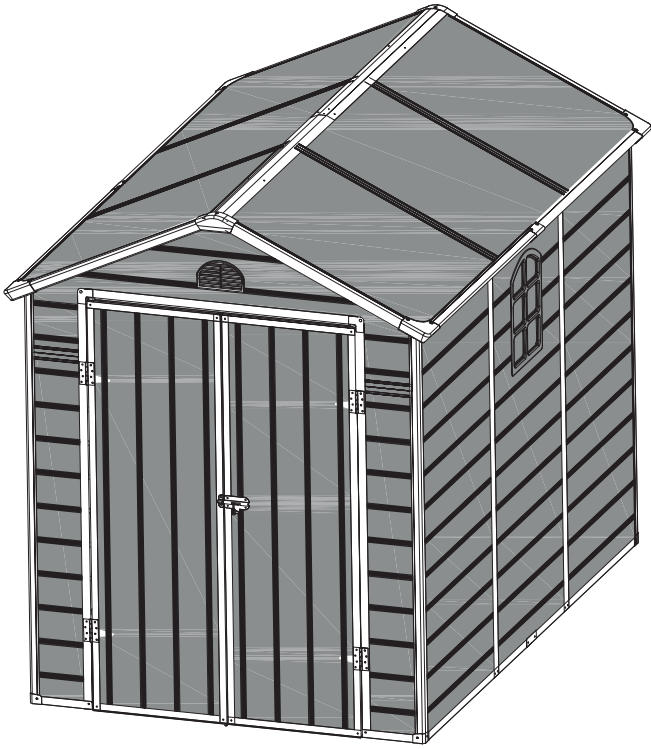

۲۷

