













 Ø8 x 35		 Ø8 x 24					
A 16x	B 16x	C 12x	D 16x	E 20x	F 20x	G 4x	H 4x
		 Ø3,5 x 16					
I 4x	J 2x	K 40x	L 1x	M 1x	N 4x	O 2x	



1

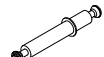

2

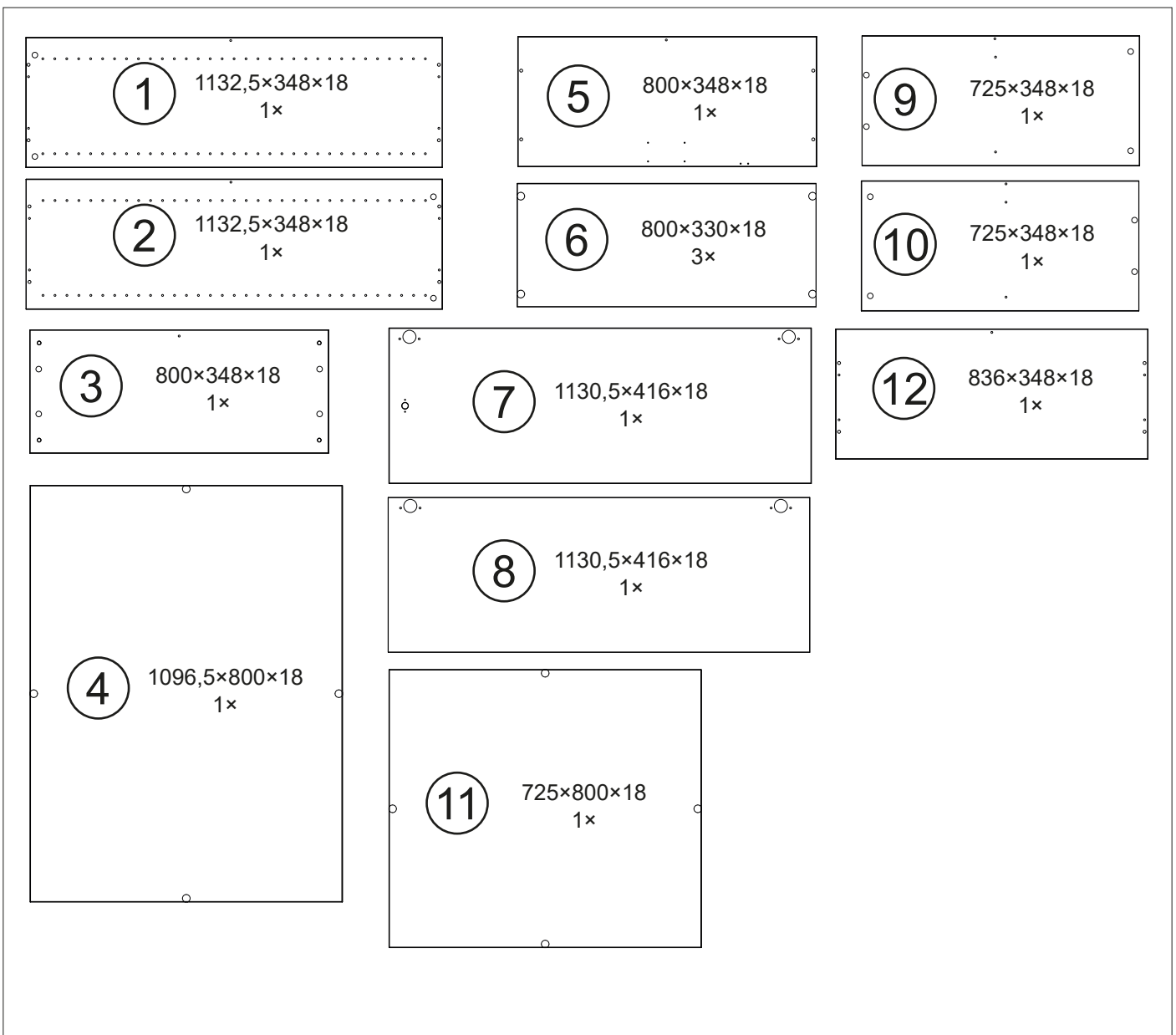
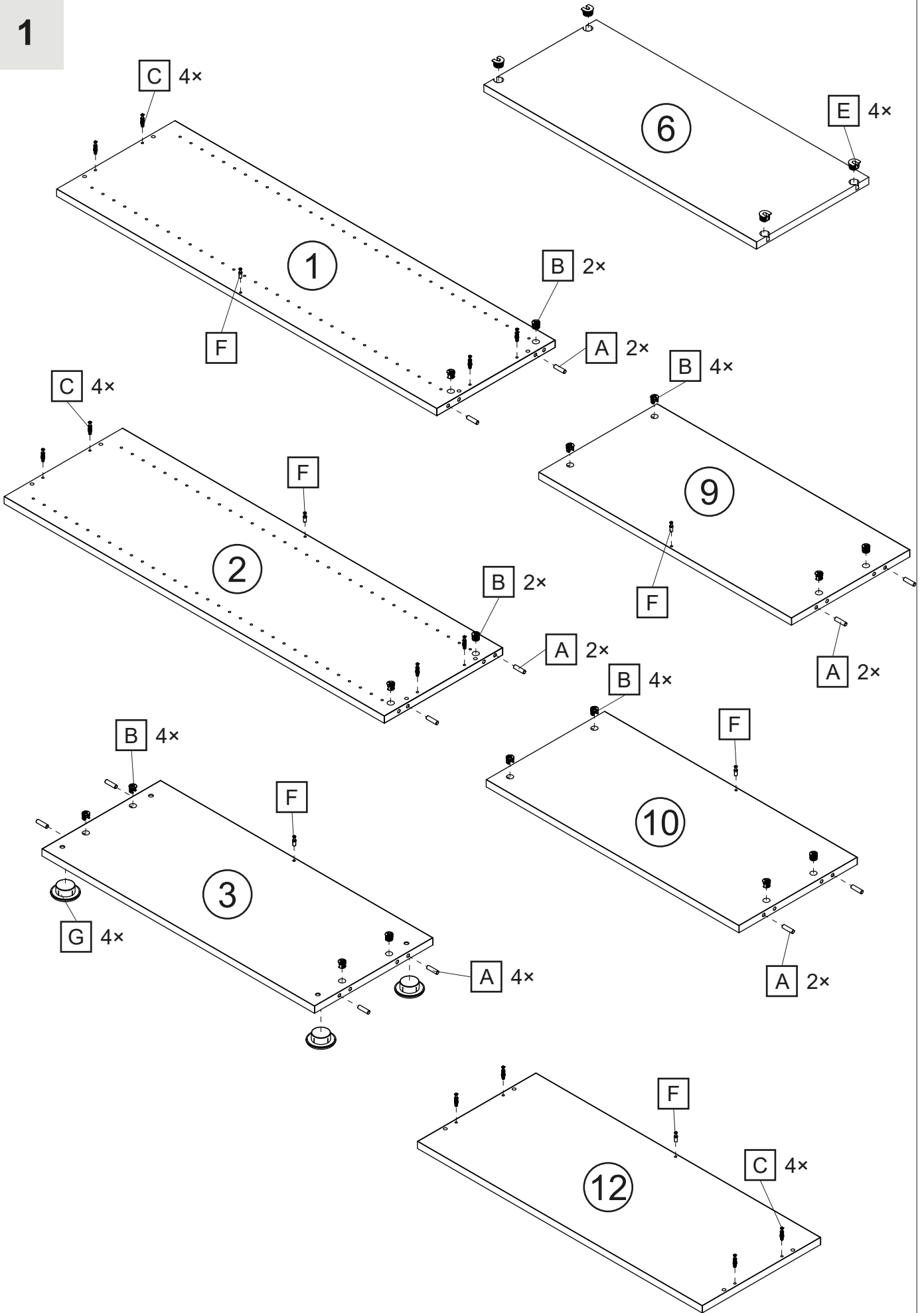
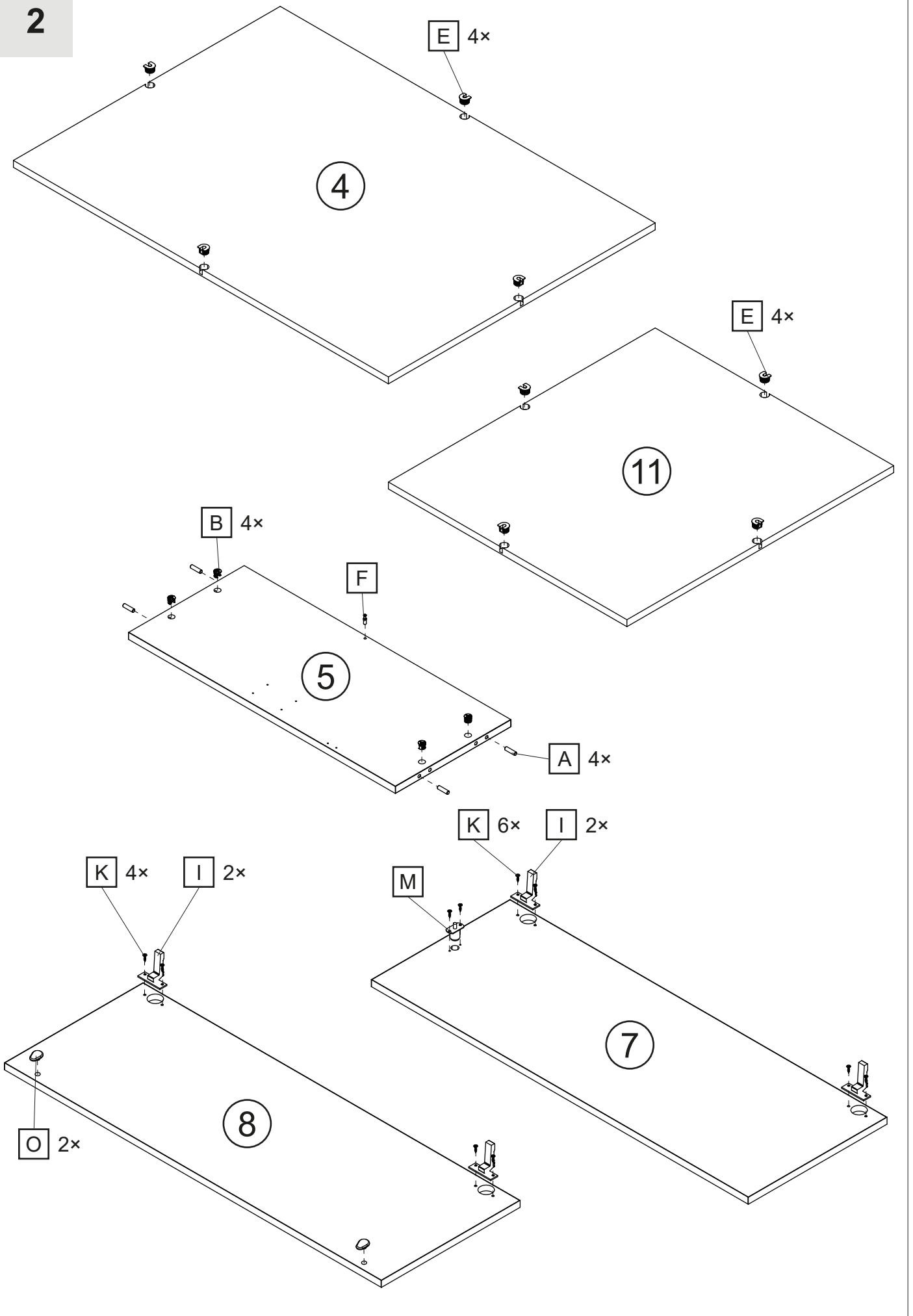

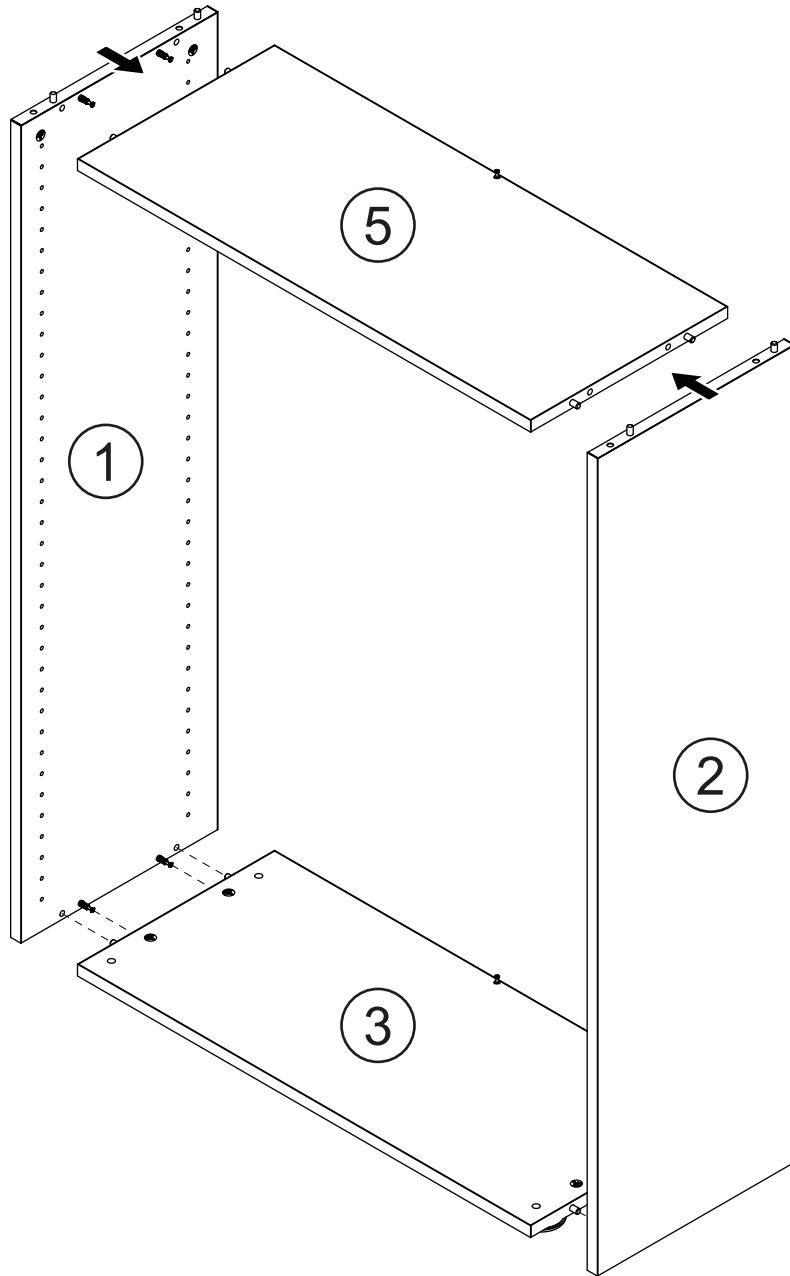

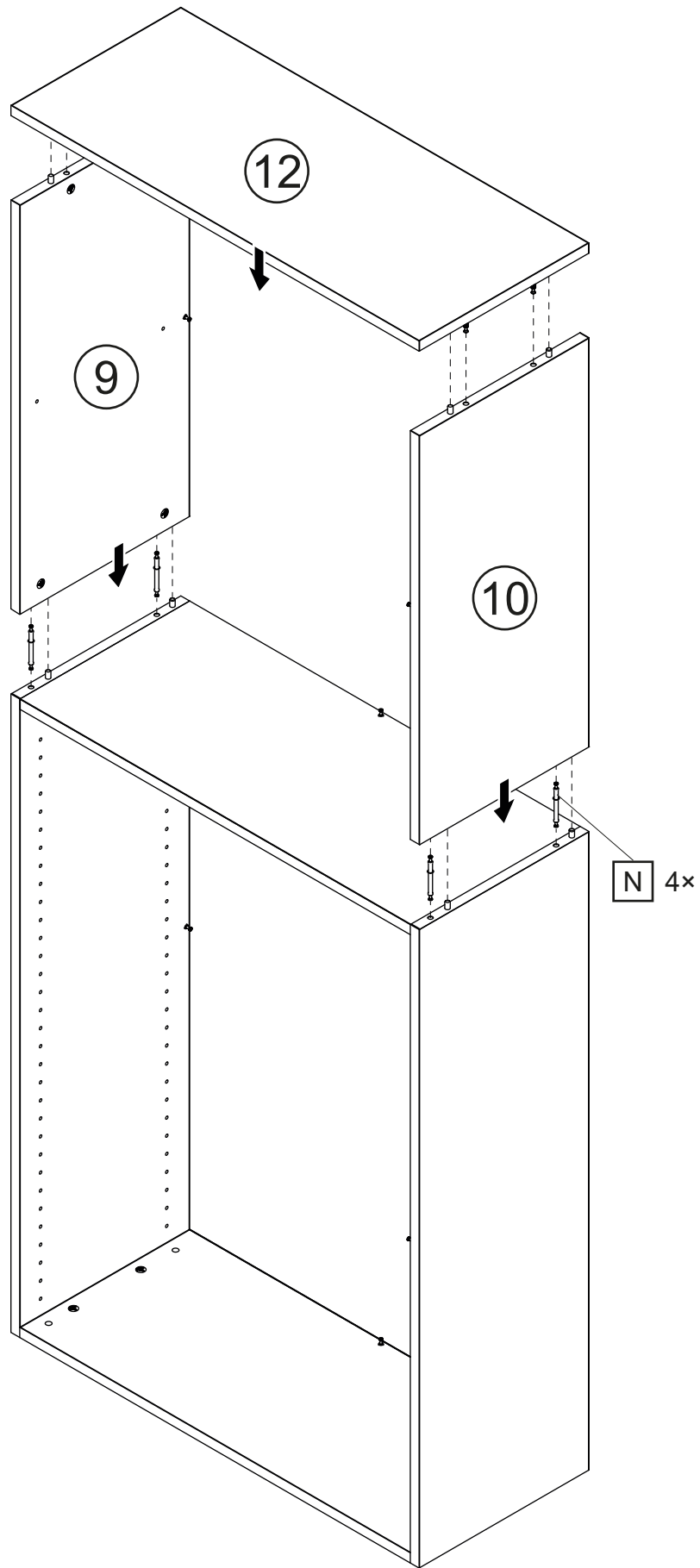

5

