













 Ø8 x 35		 Ø8 x 24					
A 24x	B 24x	C 20x	D 20x	E 40x	F 40x	G 5x	H 8x
		 Ø3,5 x 16					
I 4x	J 4x	K 84x	L 2x	M 2x	N 4x	O 4x	P 4x

 1 1132,5x348x18 1x	 9 725x348x18 1x	 13 725x348x18 1x
 2 1132,5x348x18 1x	 10 725x348x18 1x	
 16 1096,5x348x18 2x	 6 800x330x18 9x	
 7 1126,5x409,8x18 1x	 14 1126,5x409,8x18 1x	 4 1096,5x800x18 3x
 8 1126,5x409,8x18 1x	 15 1126,5x409,8x18 1x	
 3 1618x348x18 1x		
 5 1618x348x18 1x		 11 725x800x18 3x
 12 1654x348x18 1x		

1



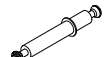

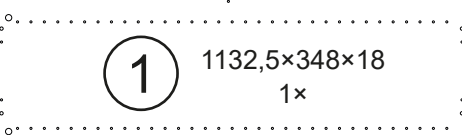
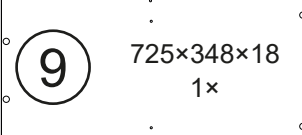
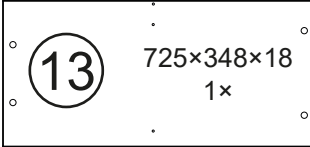
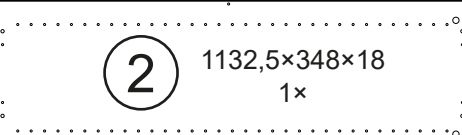
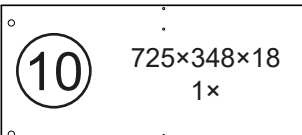
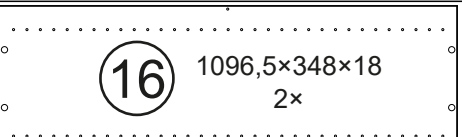
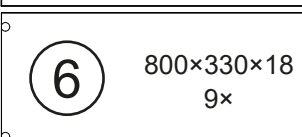
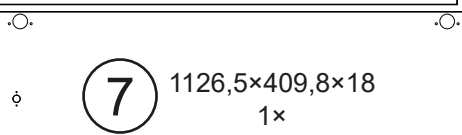
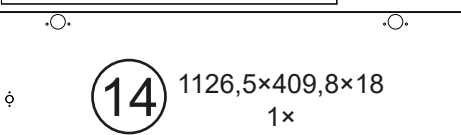
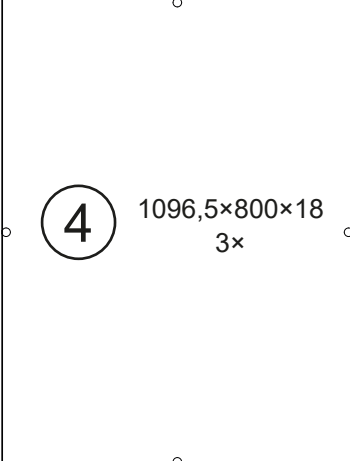
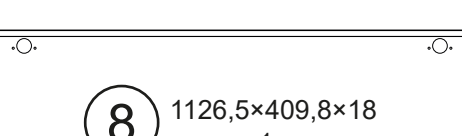
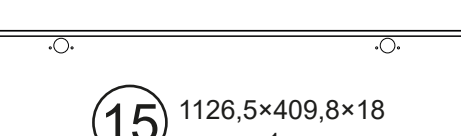
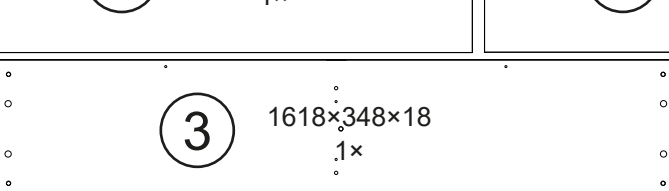
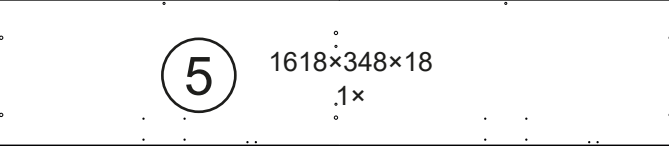
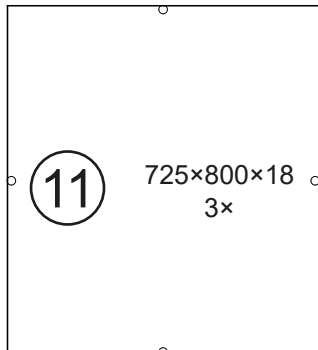
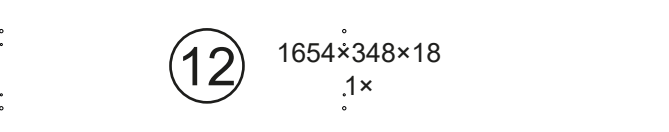
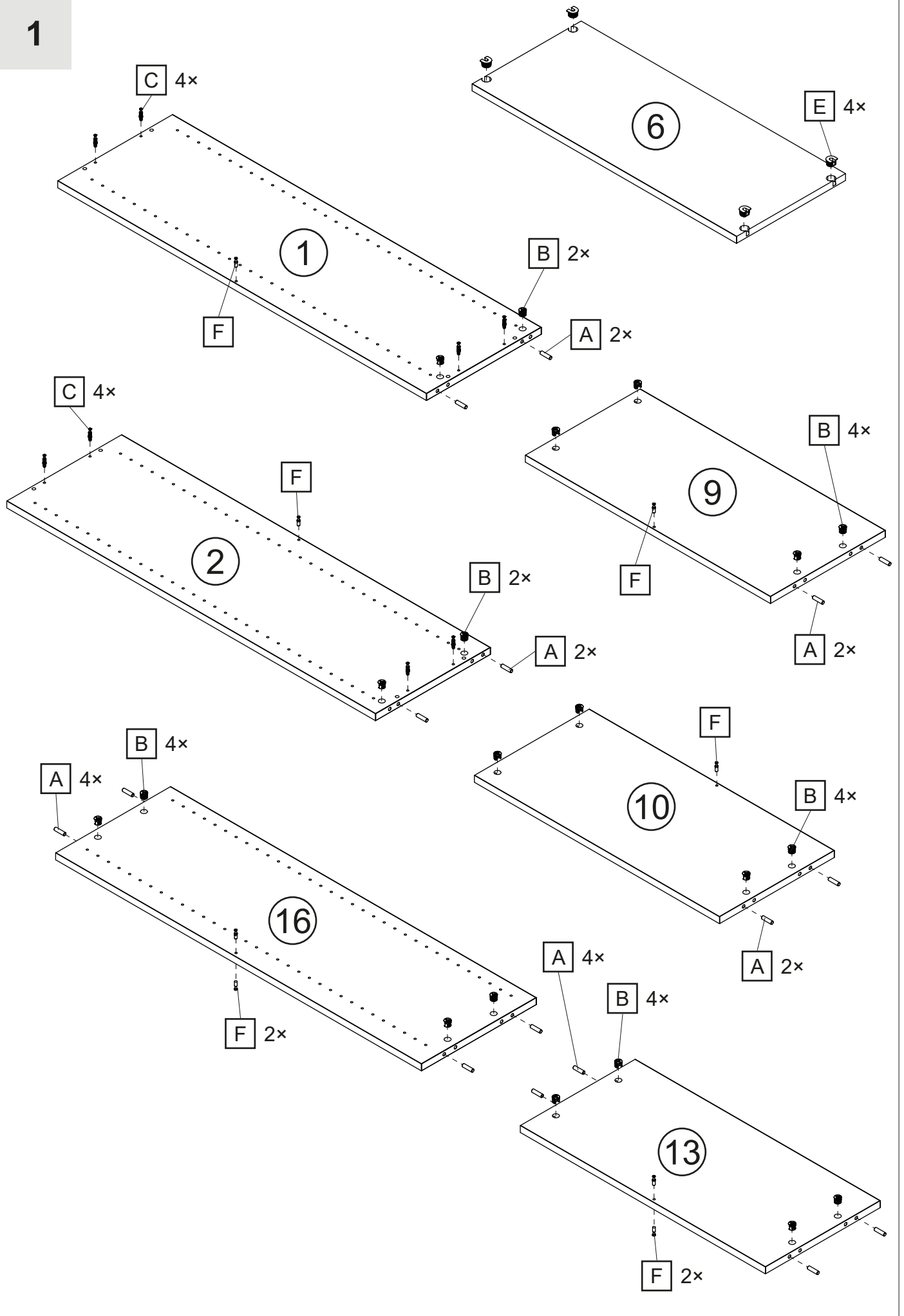
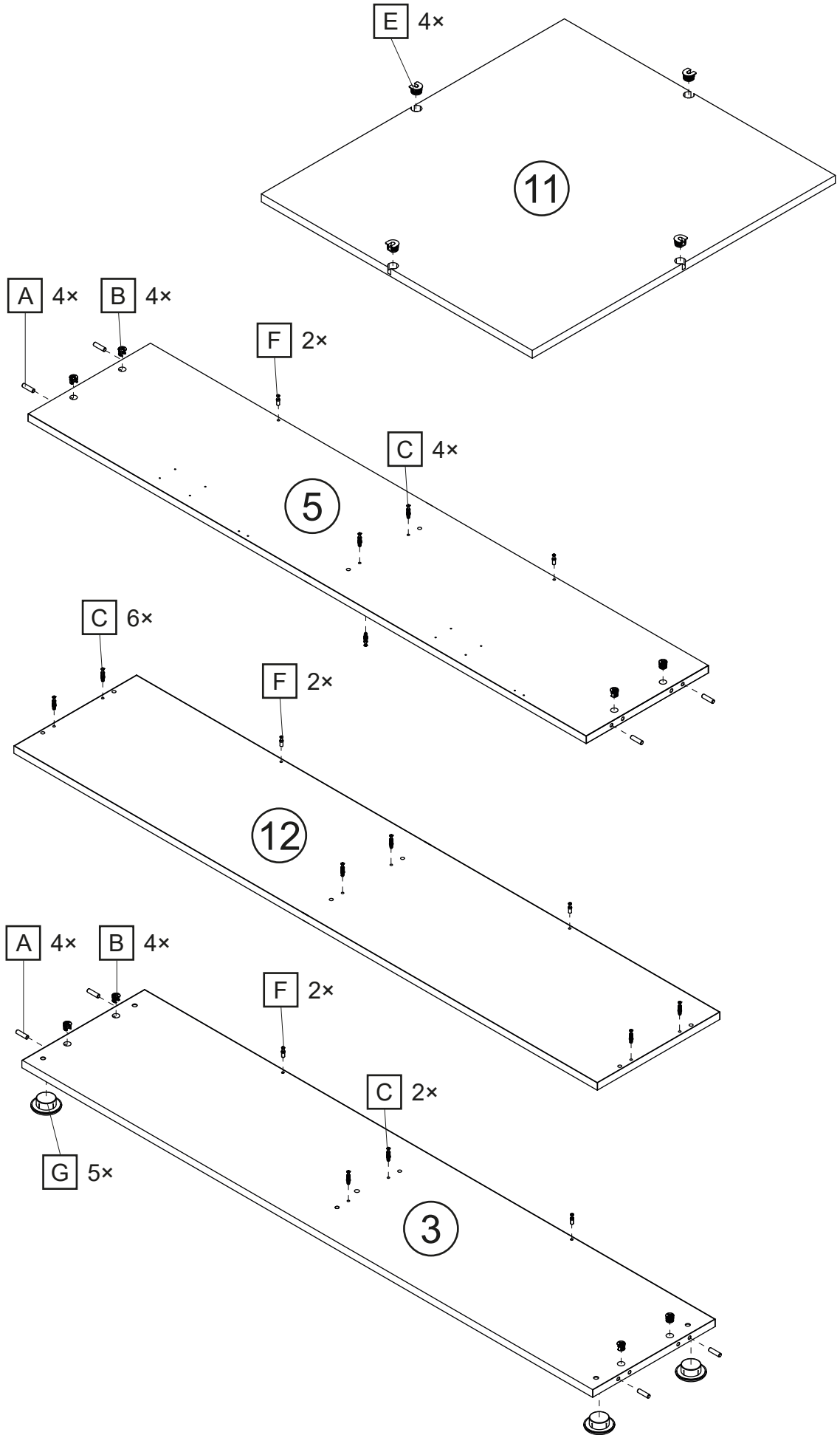
3

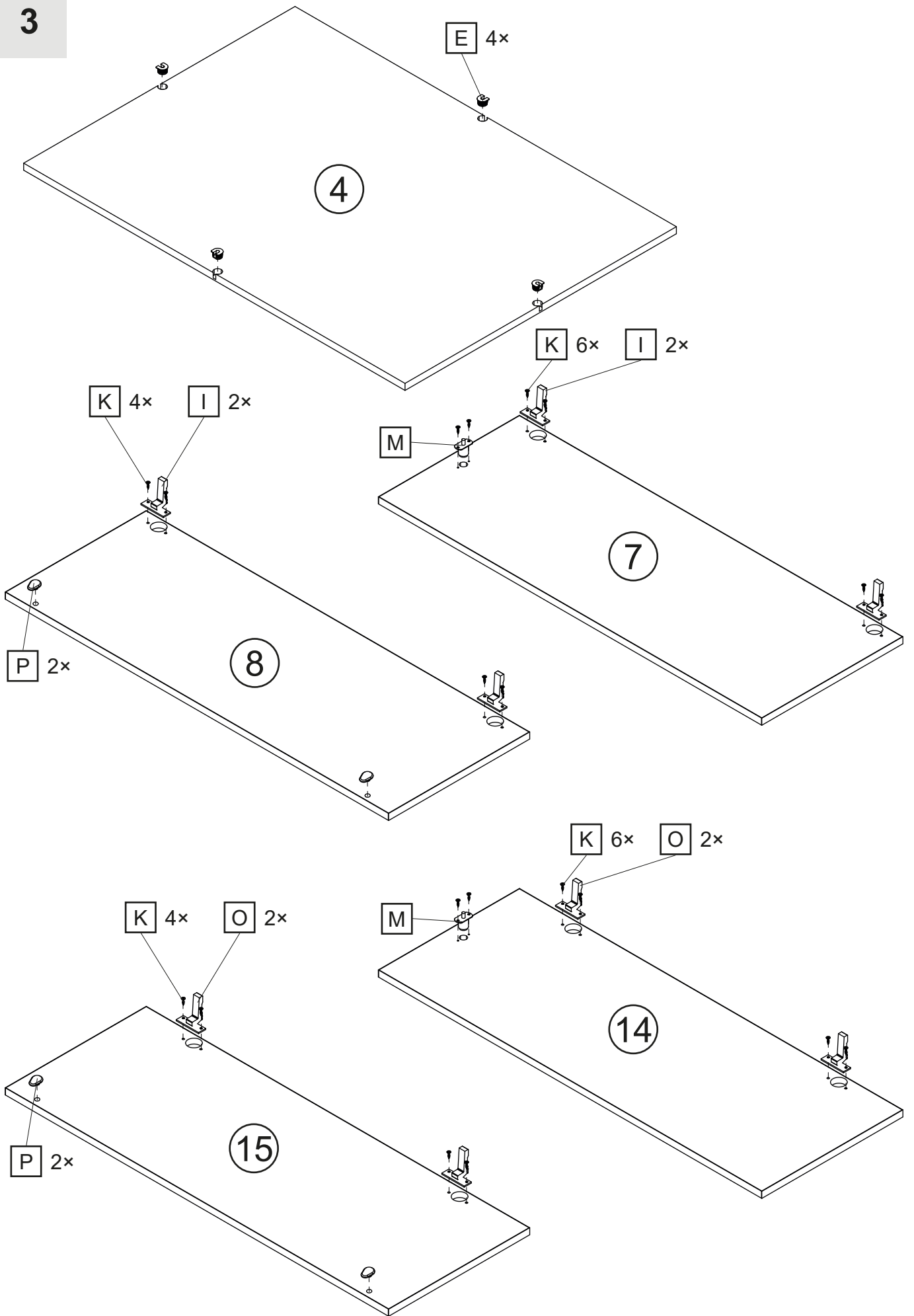

4

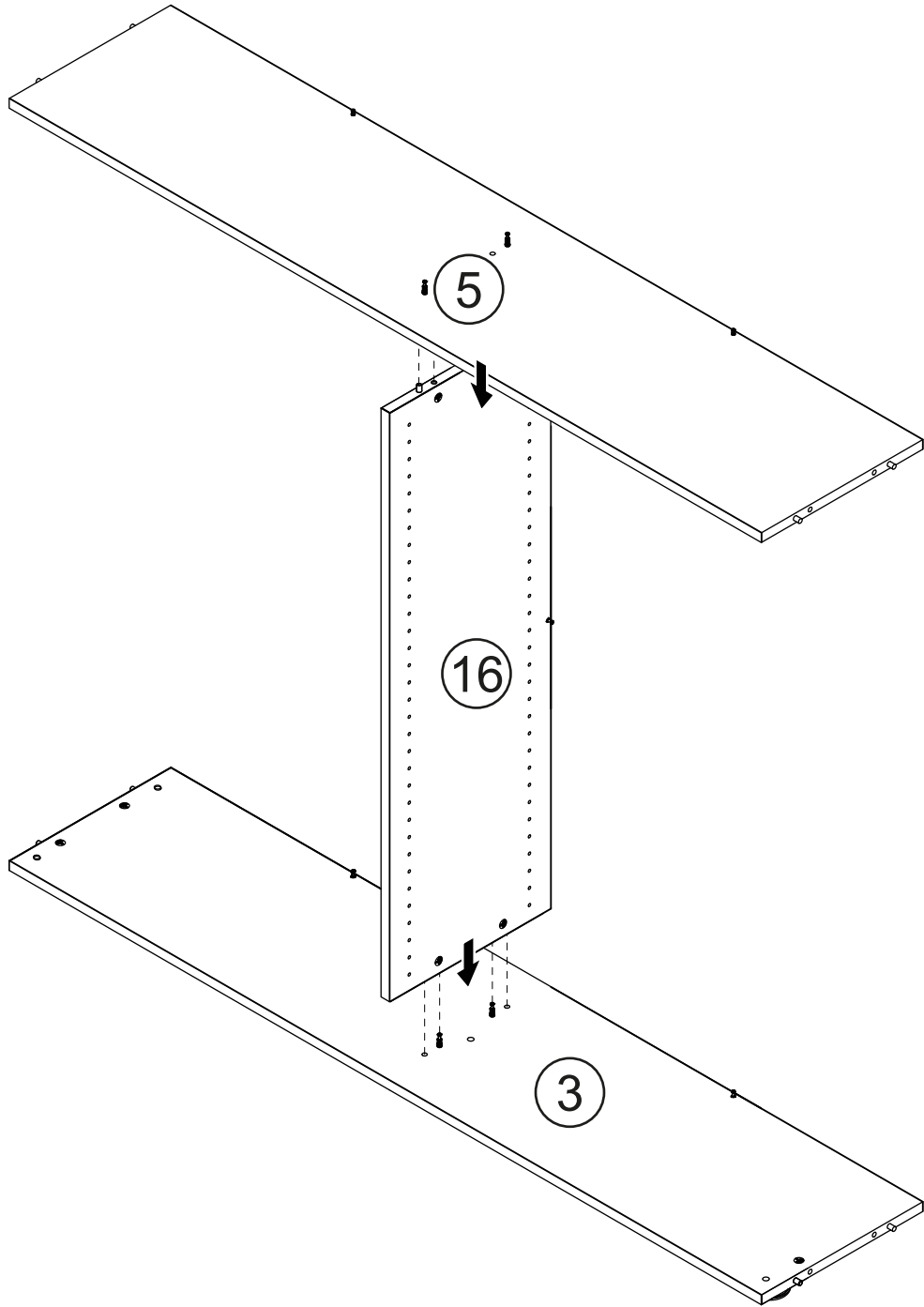

5

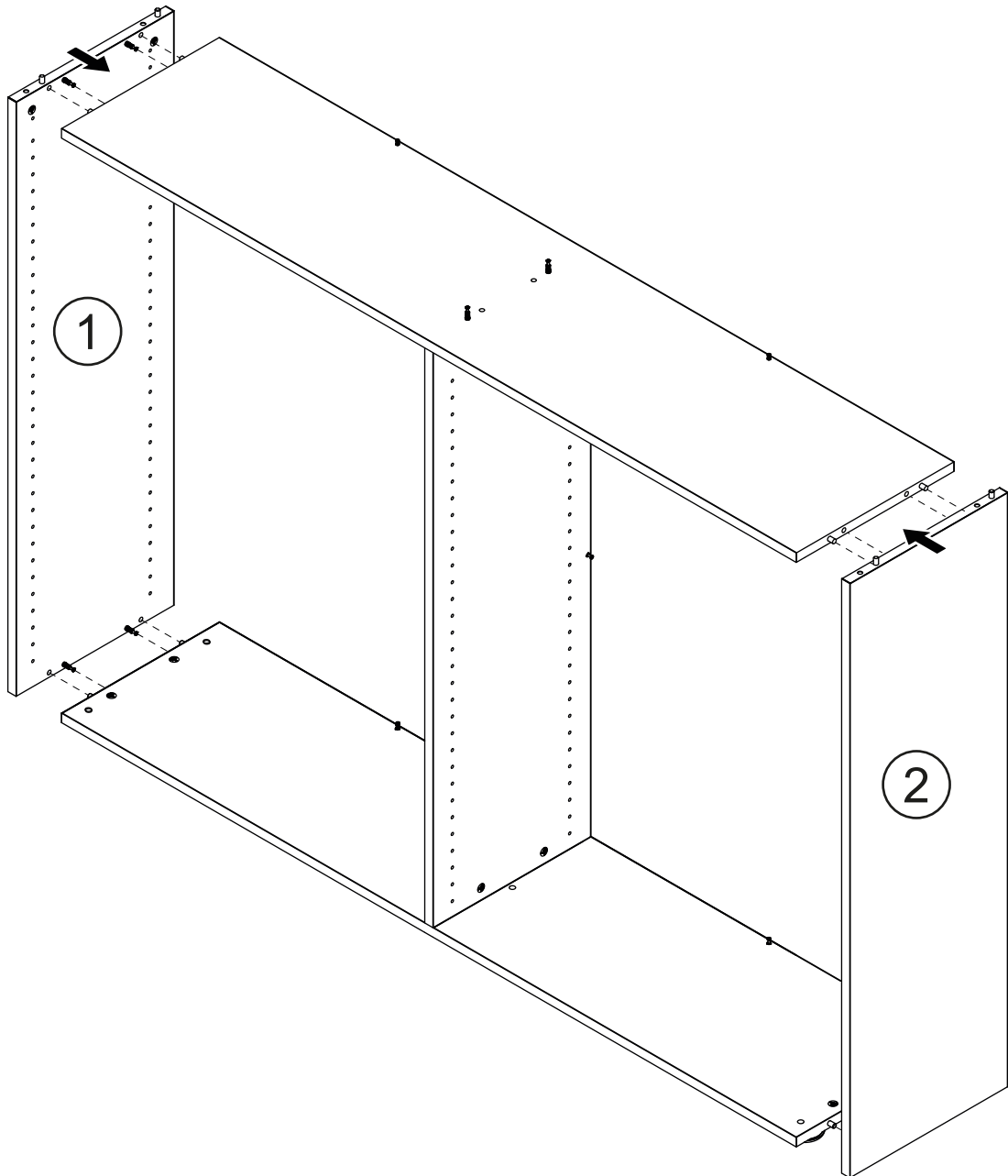

6

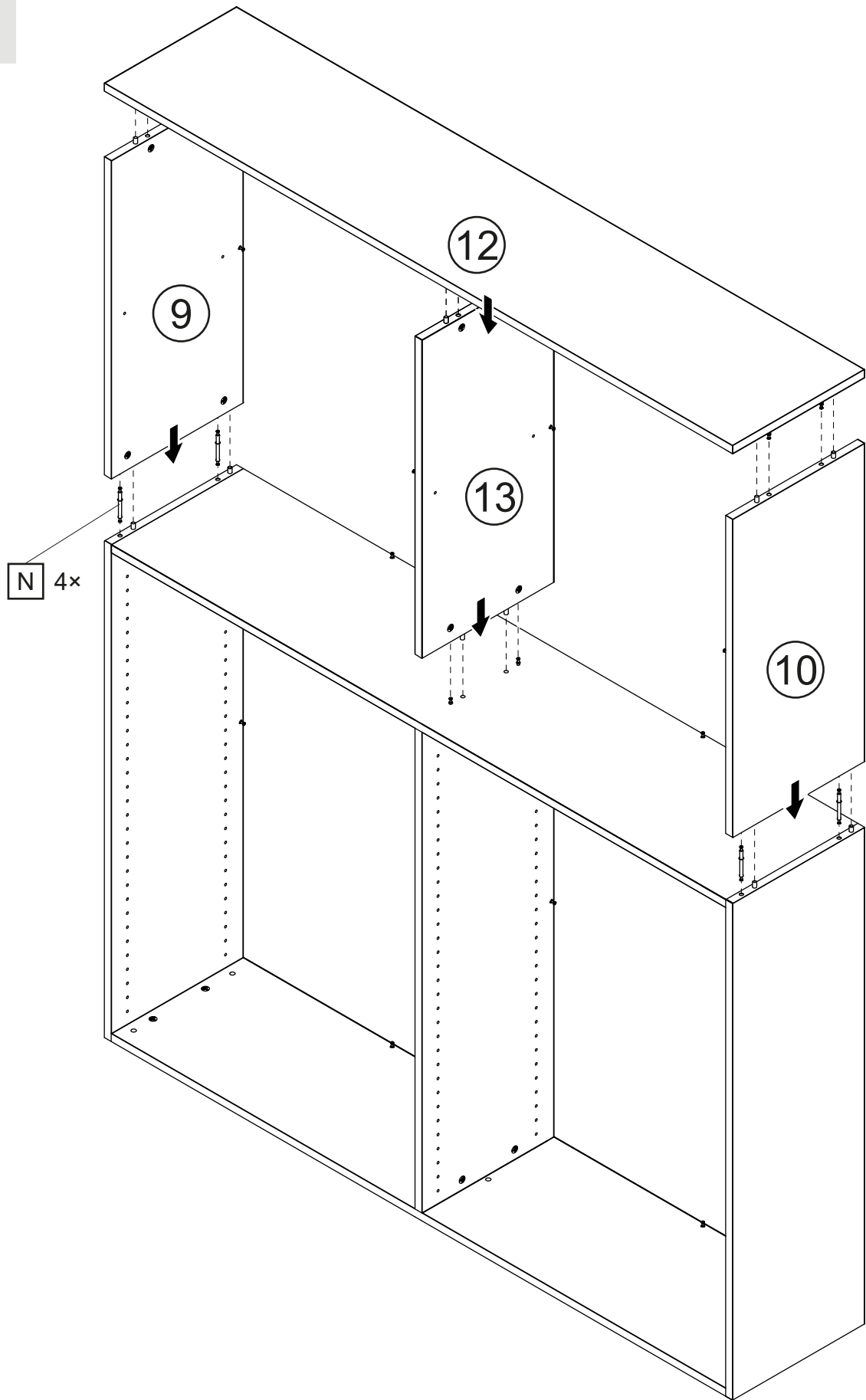

7

