



Ø8 x 35		Ø8 x 24			Ø3,5 x 16		
A 26x	B 28x	C 28x	D 28x	E 8x	F 8x	G 5x	H 4x
							
I 4x	J 2x						



1

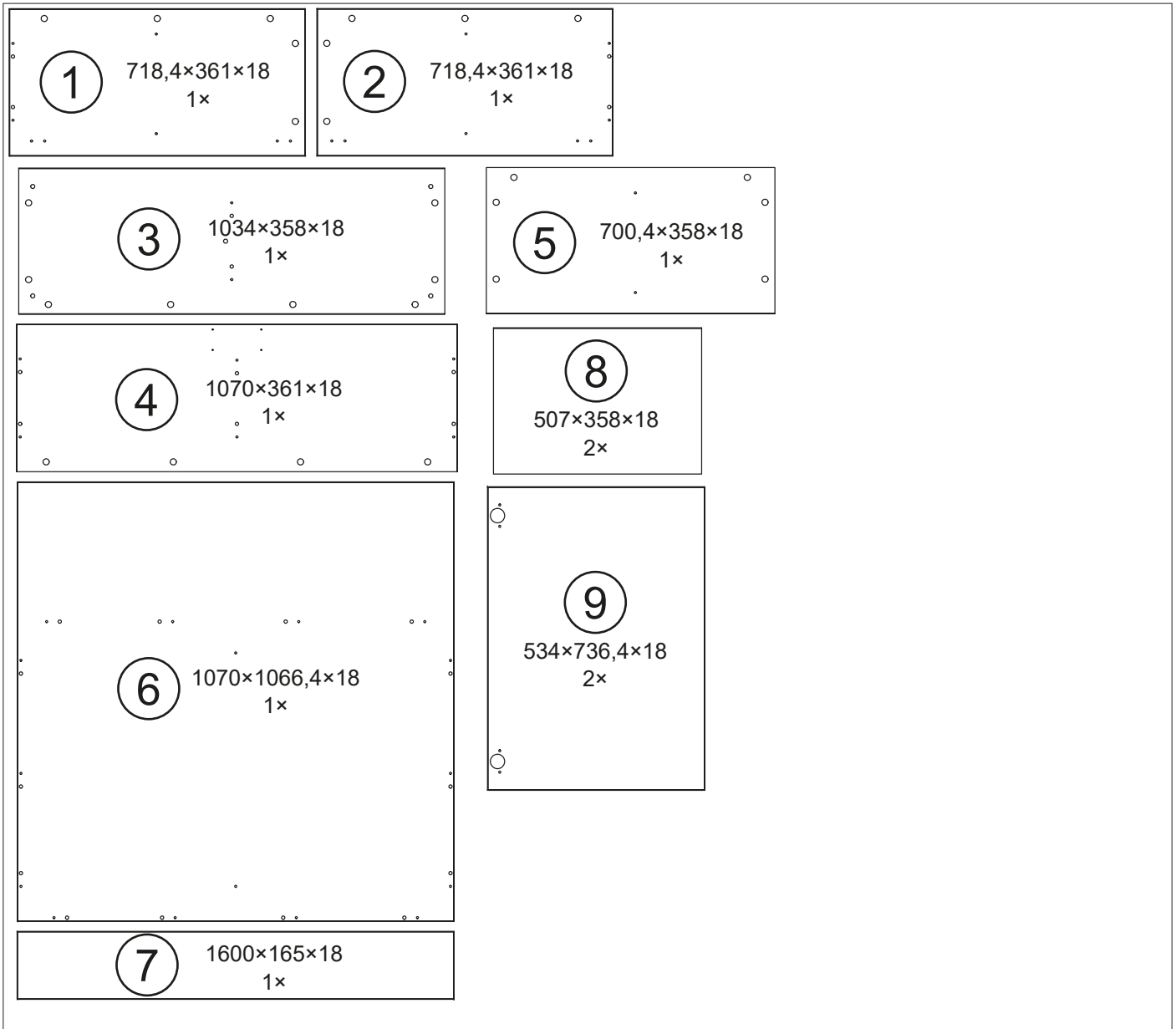
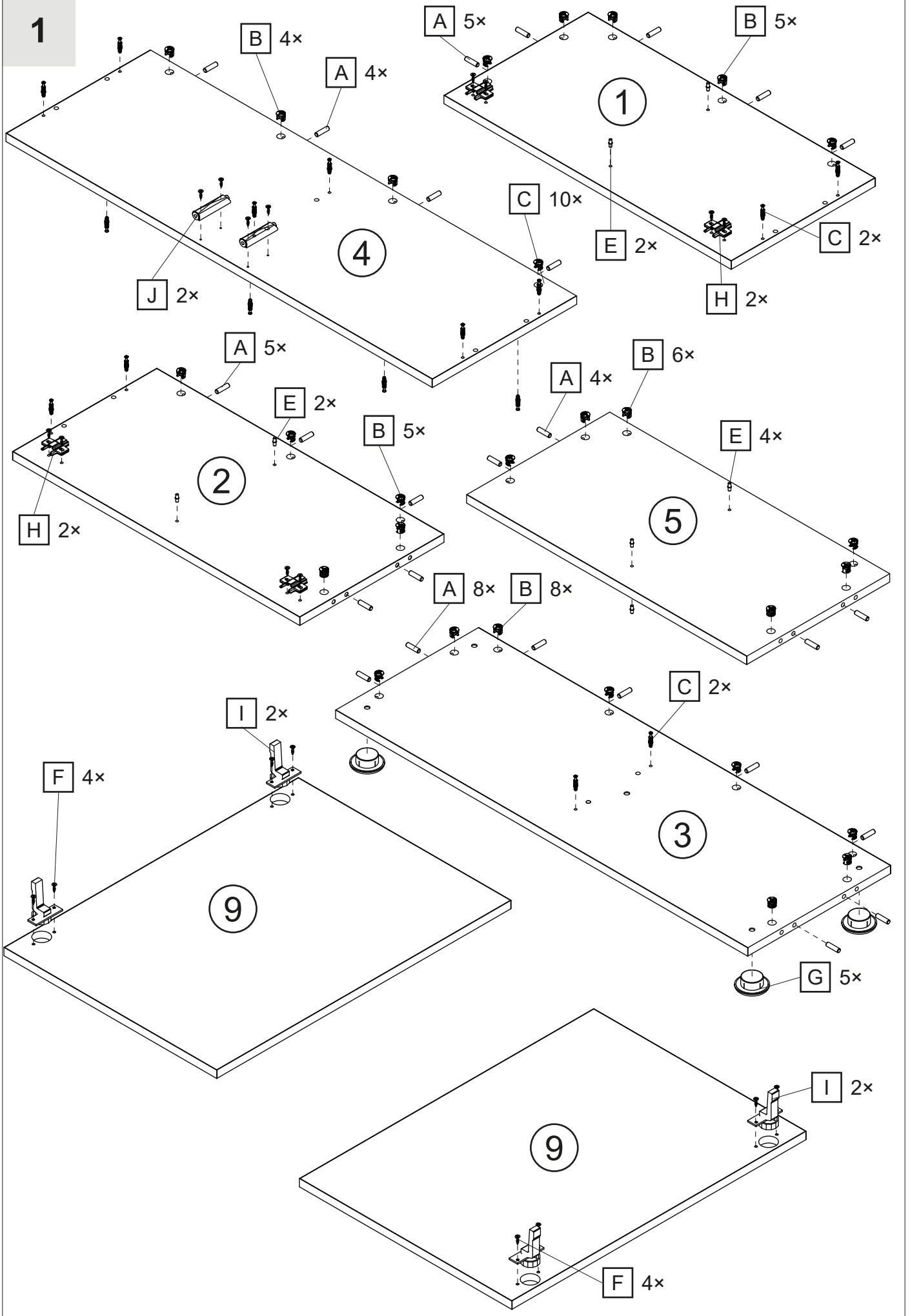
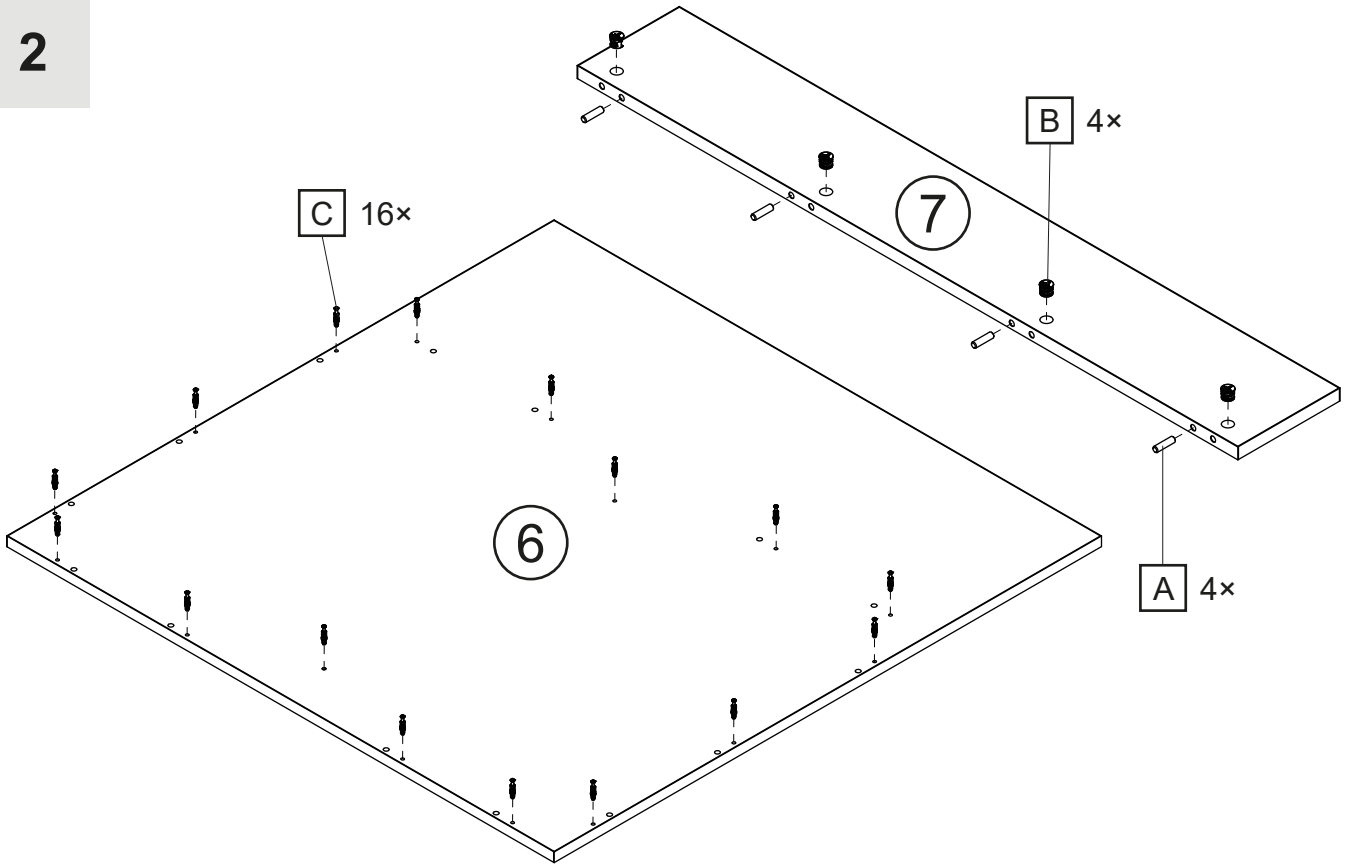

2



3

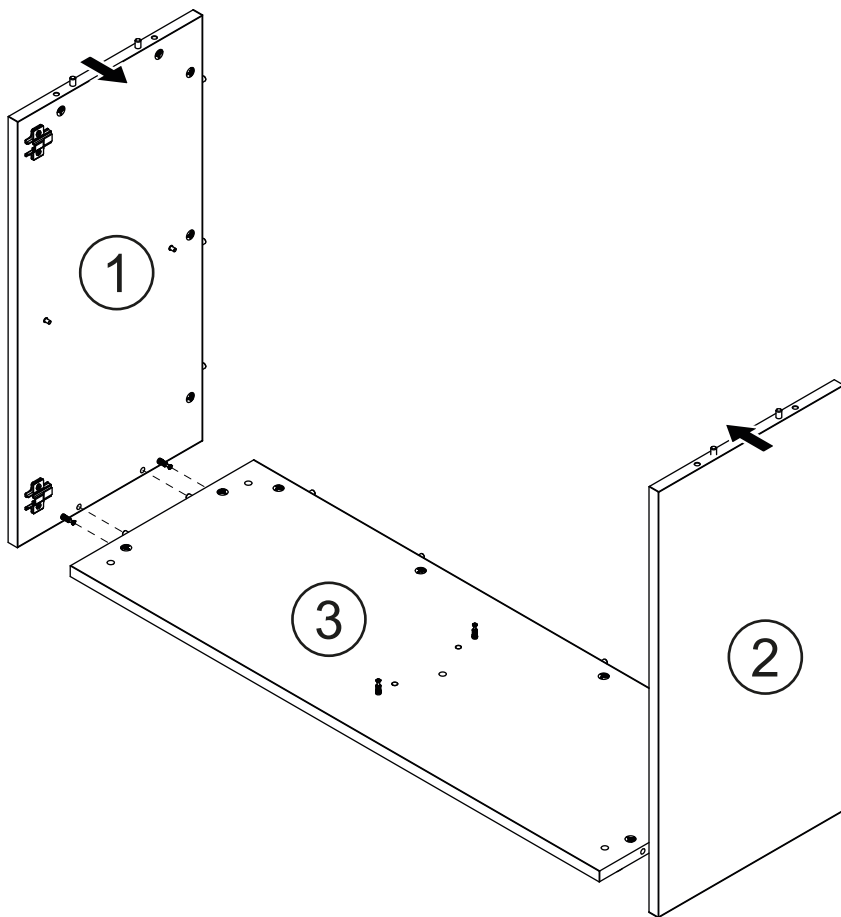

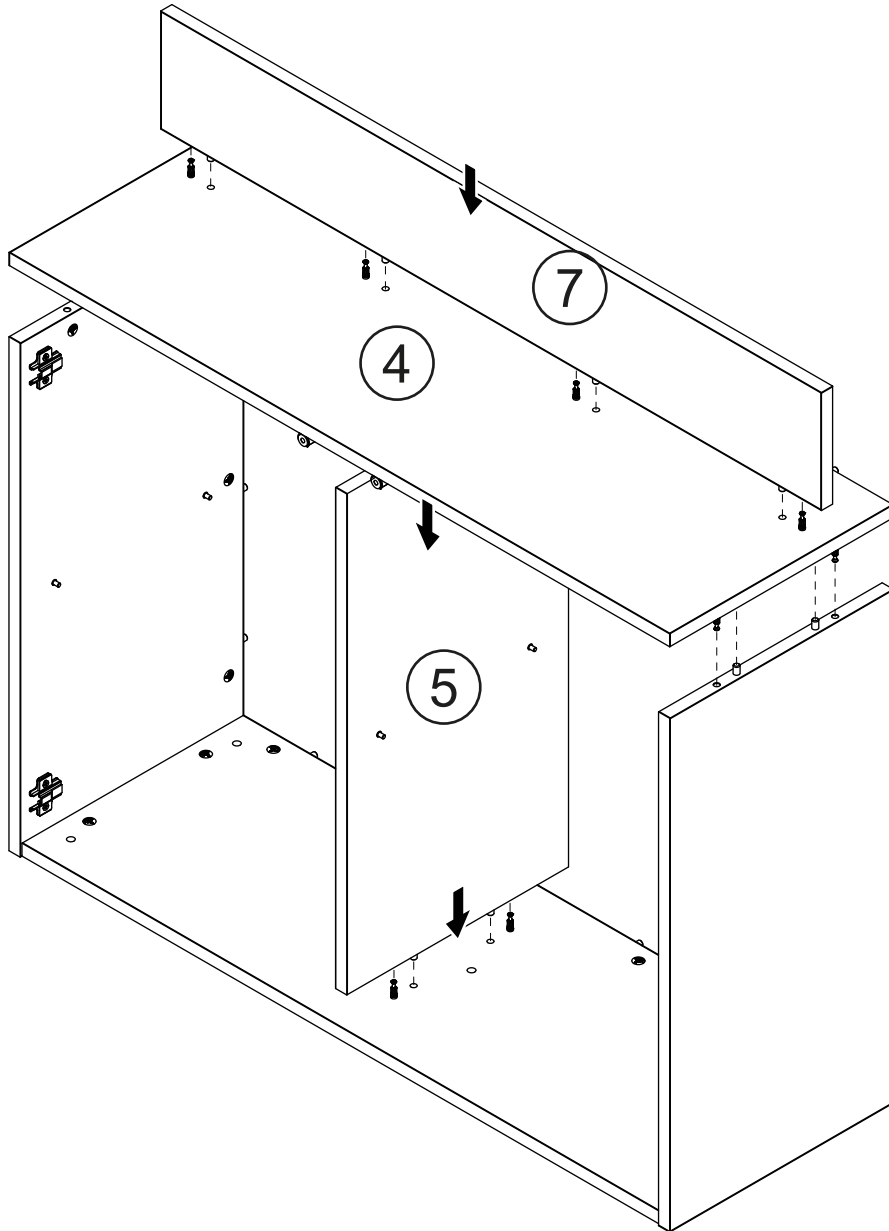

5

