









| | | | | | | | |
|---|---|---|---|---|---|---|---|
|  |  |  |  |  |  |  |  |
| Ø8 × 35 | | Ø8 × 24 | | Ø3,5 × 16 | 35/16 | 35/16 | |
| A 8× | B 8× | C 8× | D 8× | E 4× | F 10× | G 10× | H 6× |

| |
|---|
|  |
| I 2× |



1

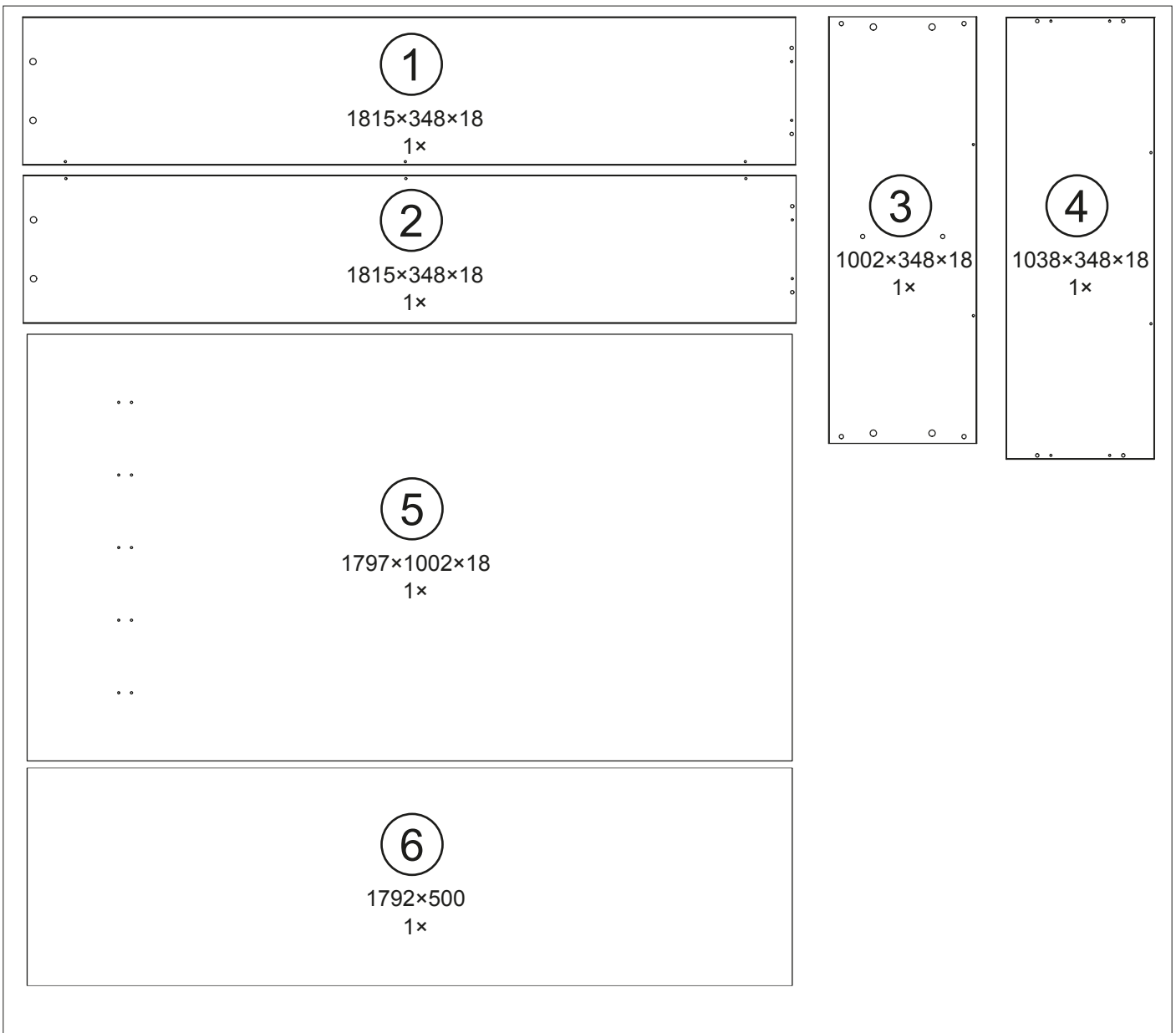
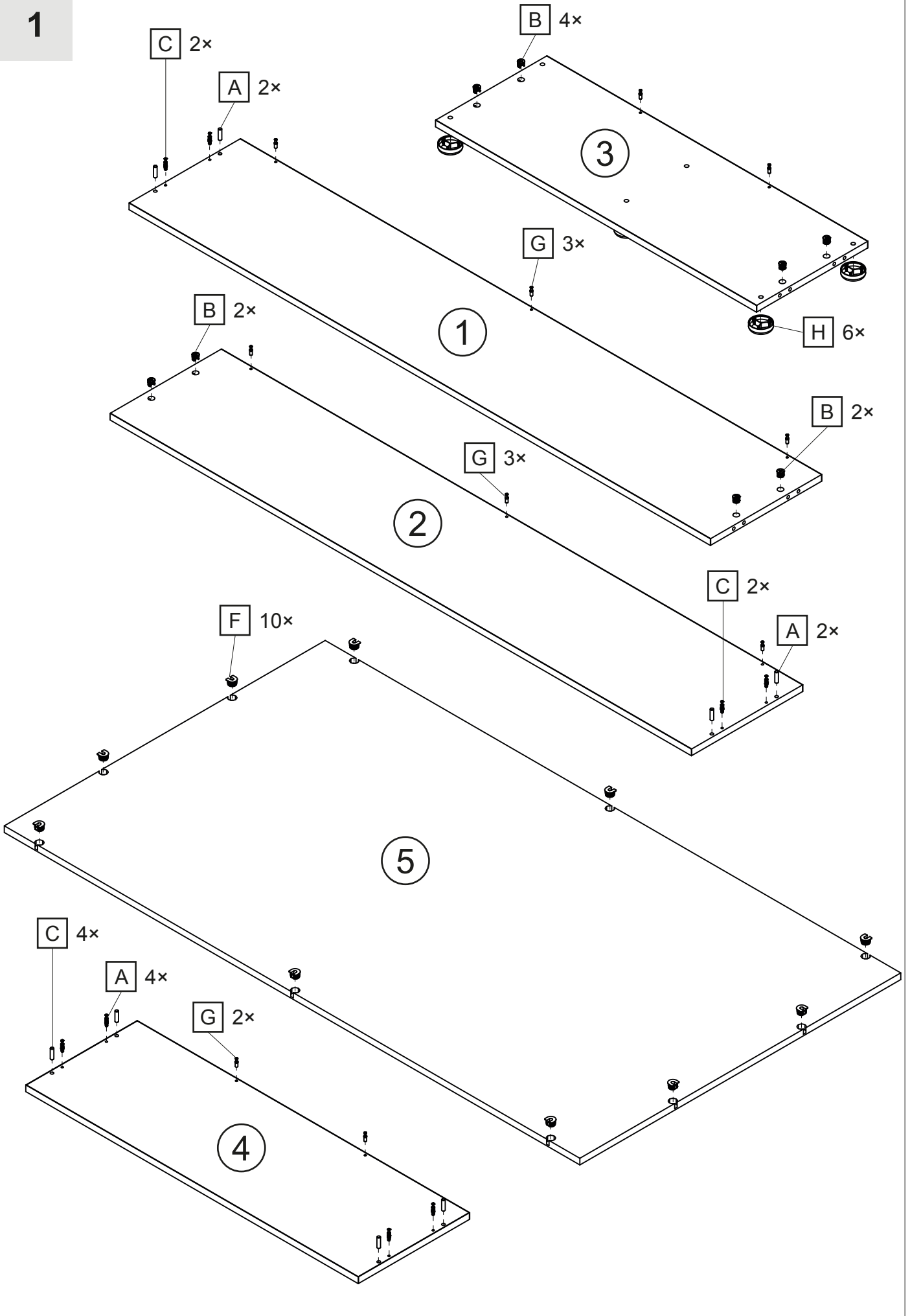

2

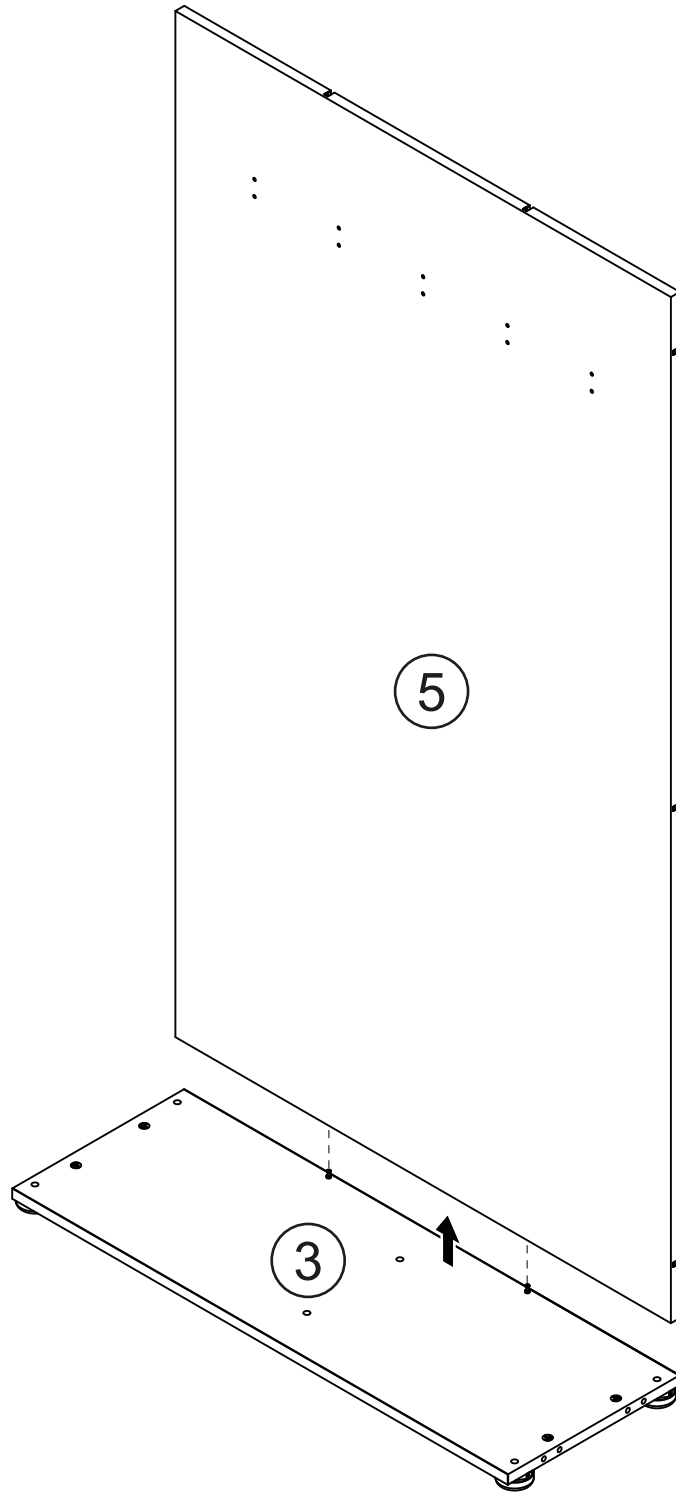

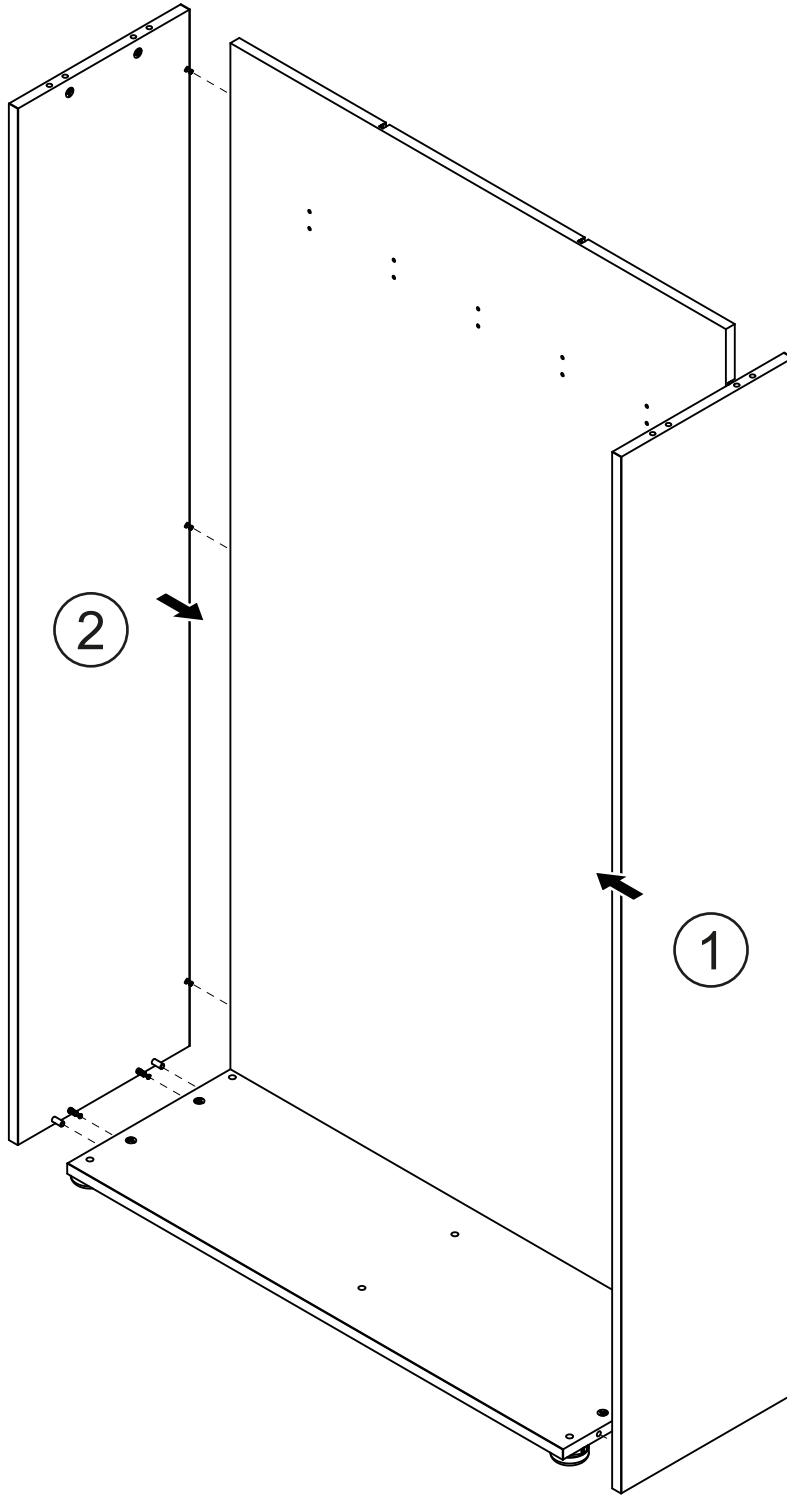

4

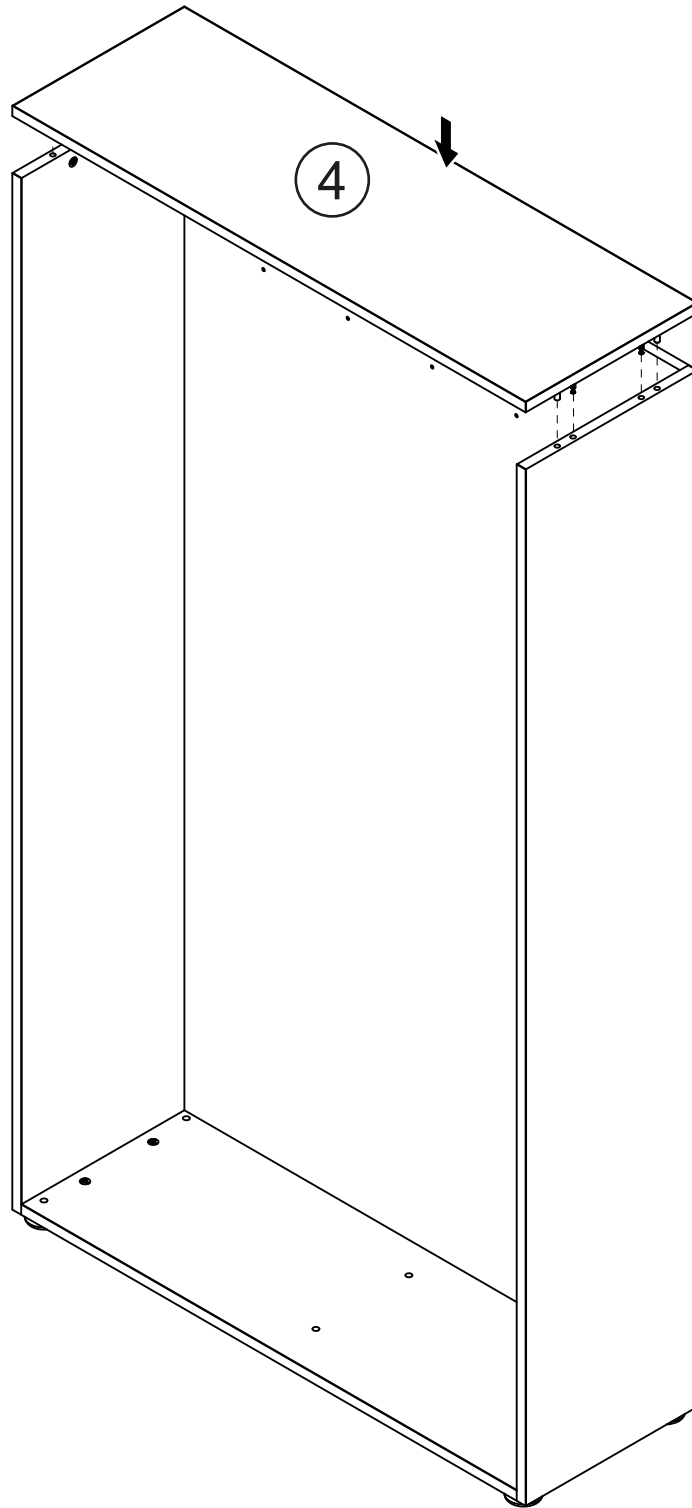

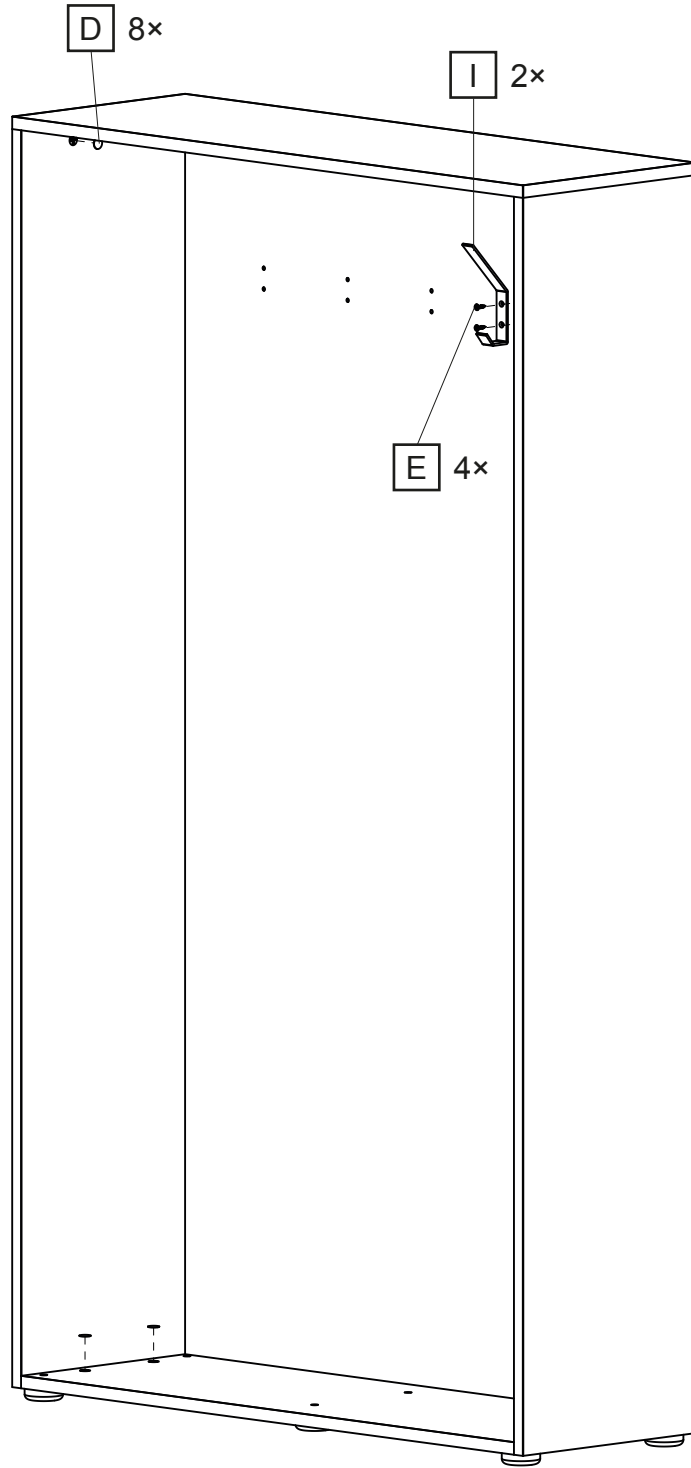

6

