

Ø8 × 35						
A 16×	B 12×	C 12×	D 12×	E 8×	F 8×	G 1×
						
H 1×						

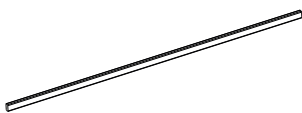

1

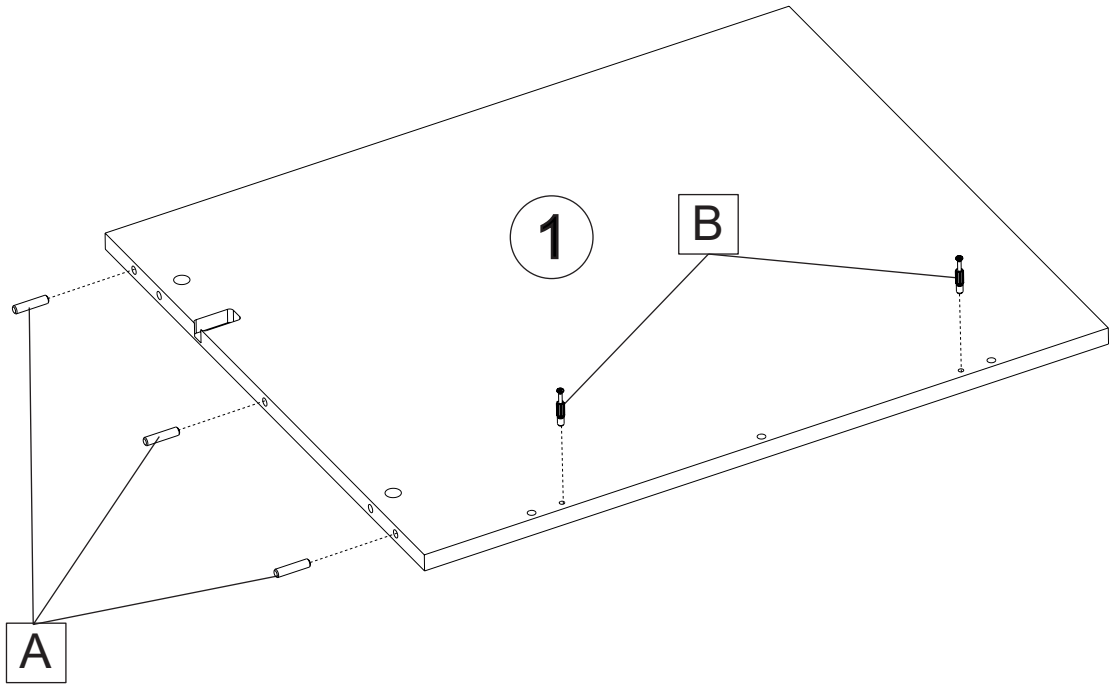
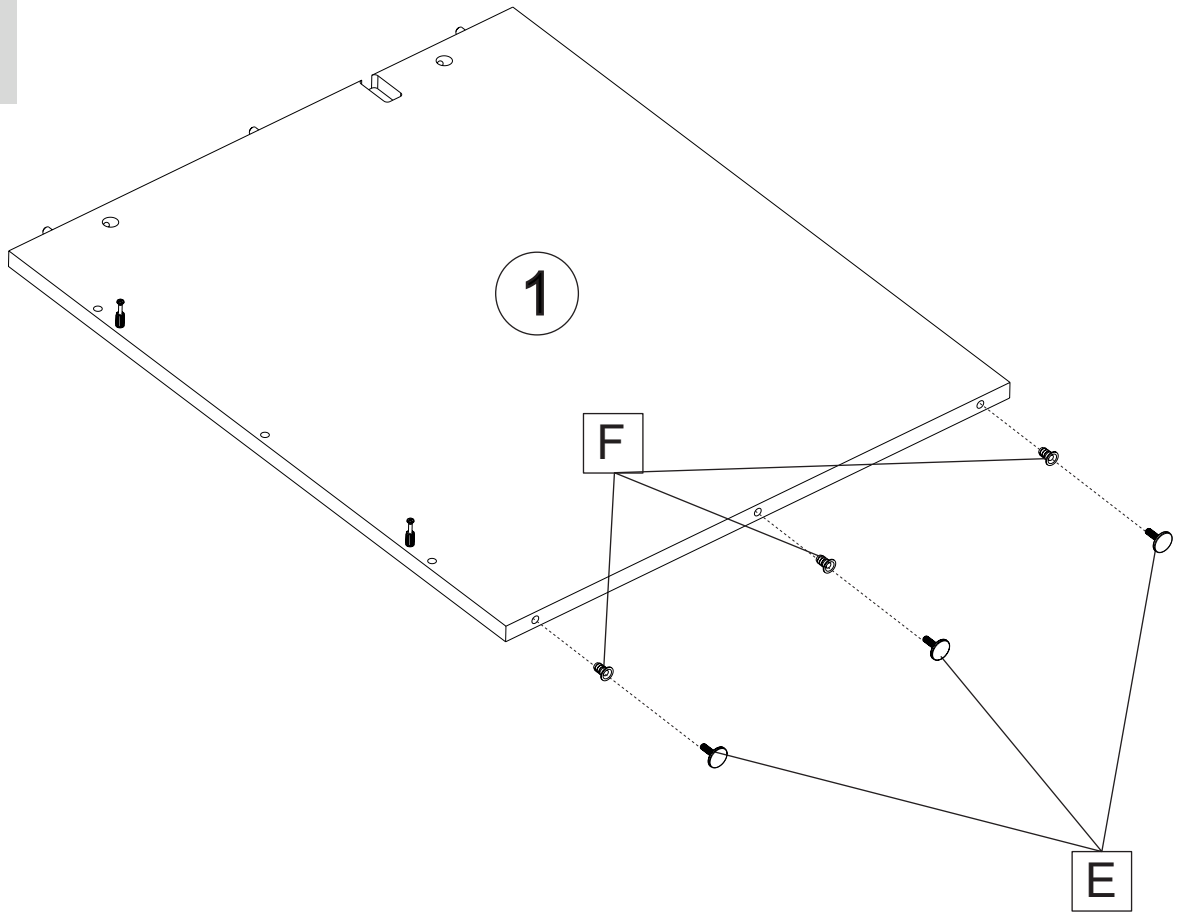

2



3

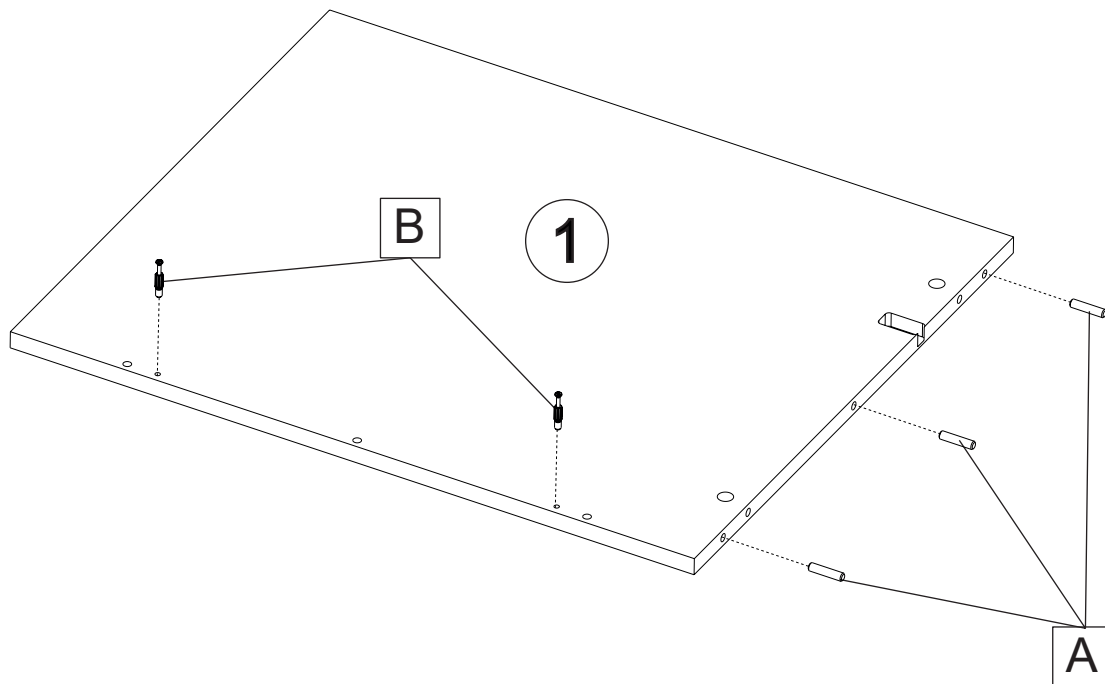

4

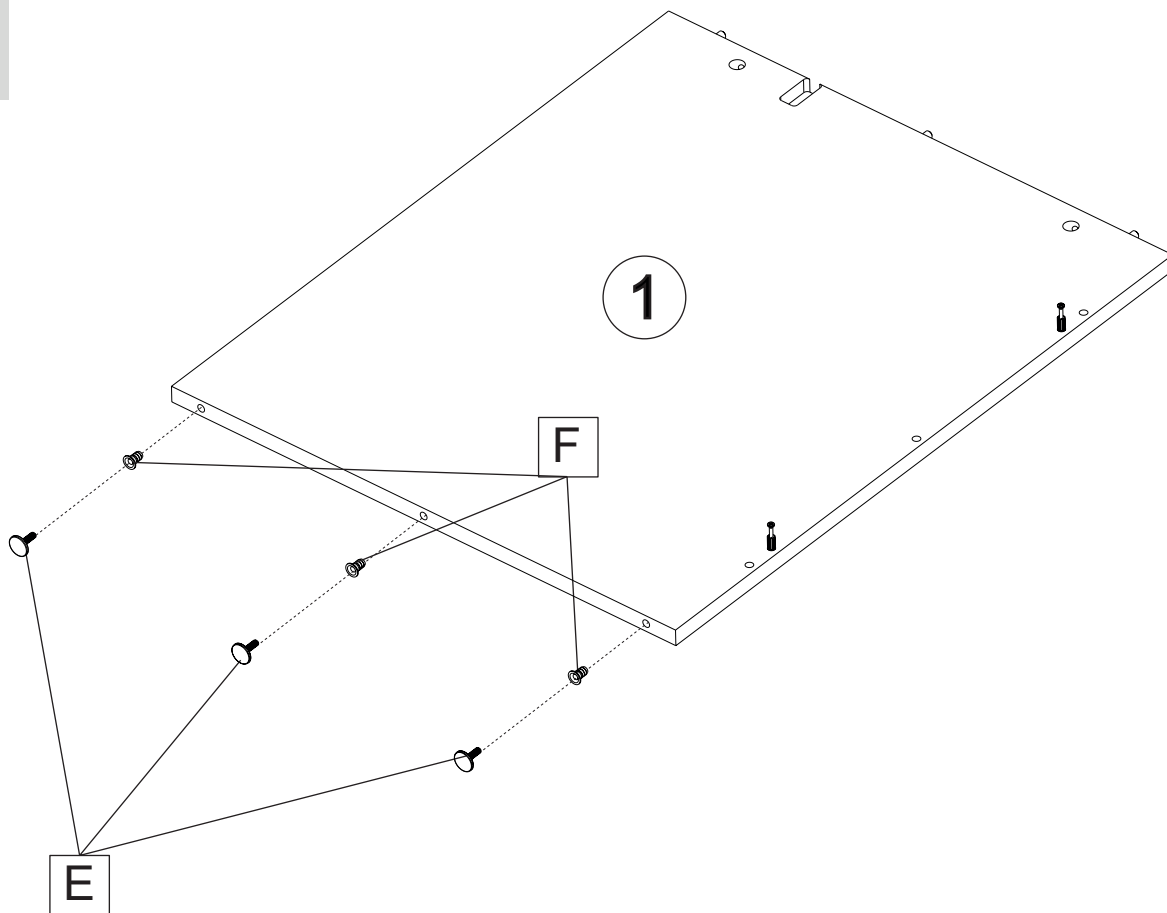

5

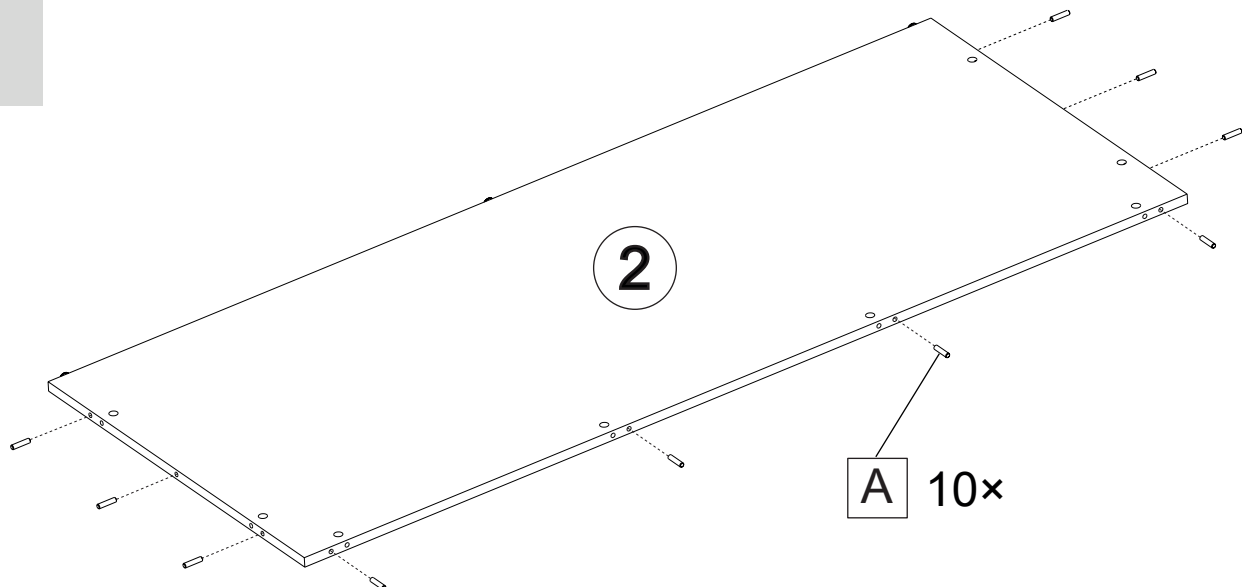

6

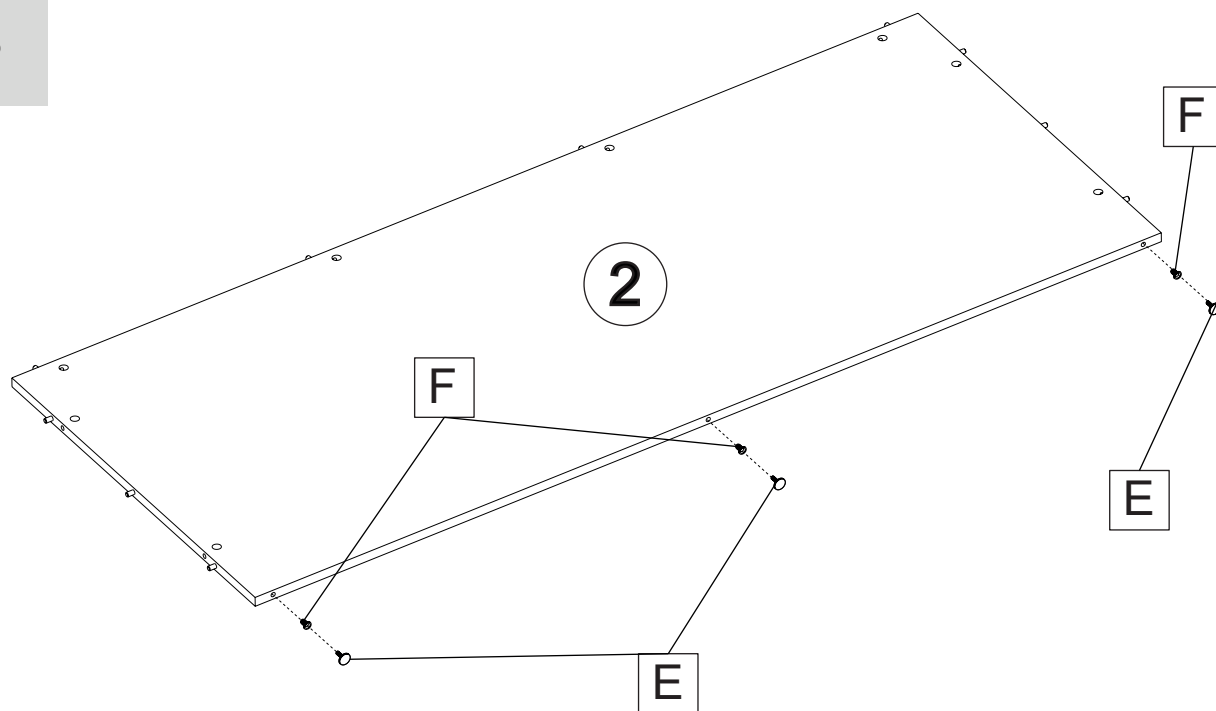

7

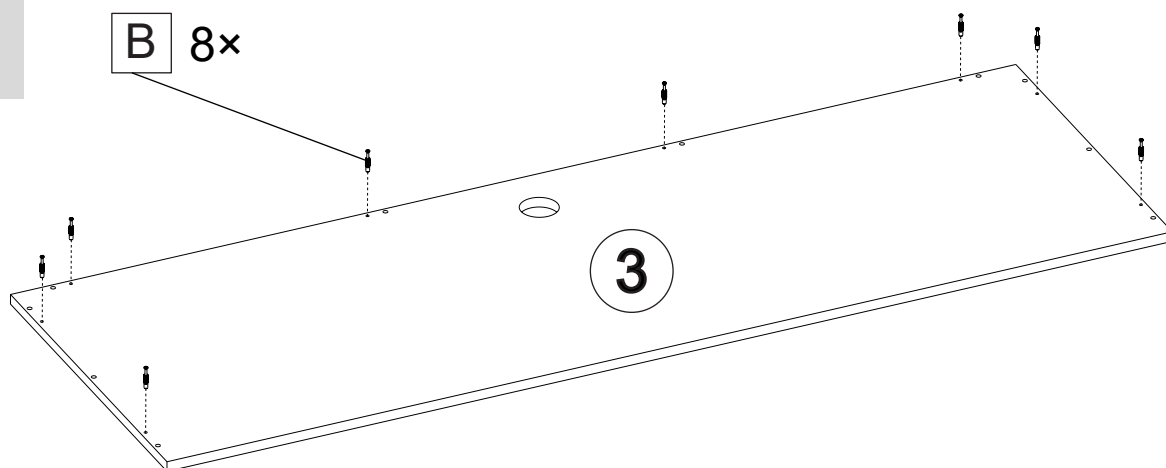

8

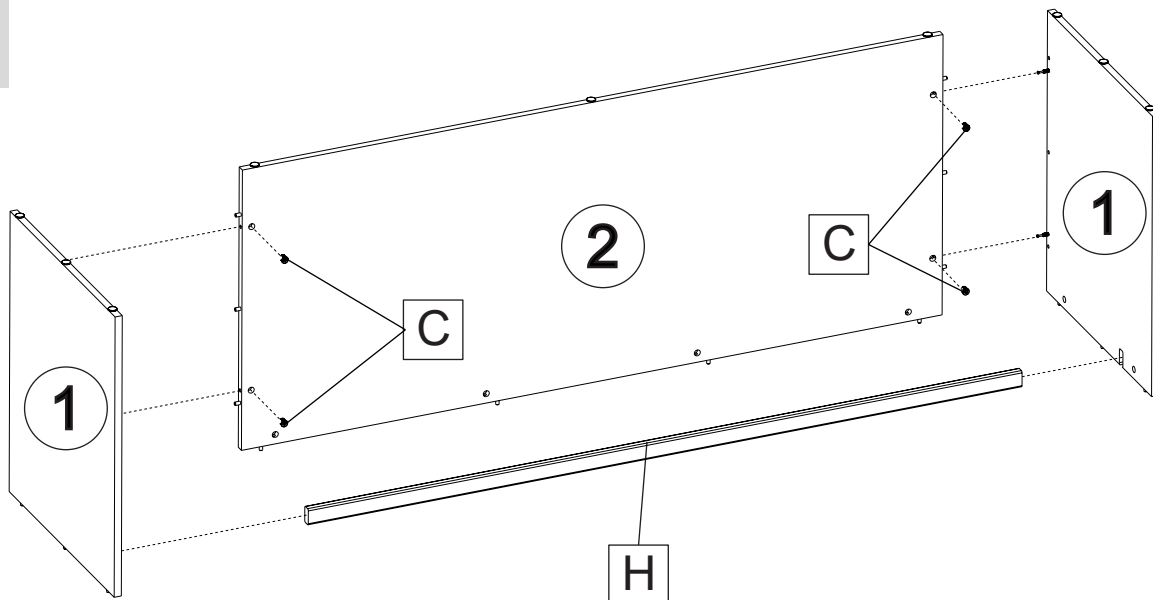

9

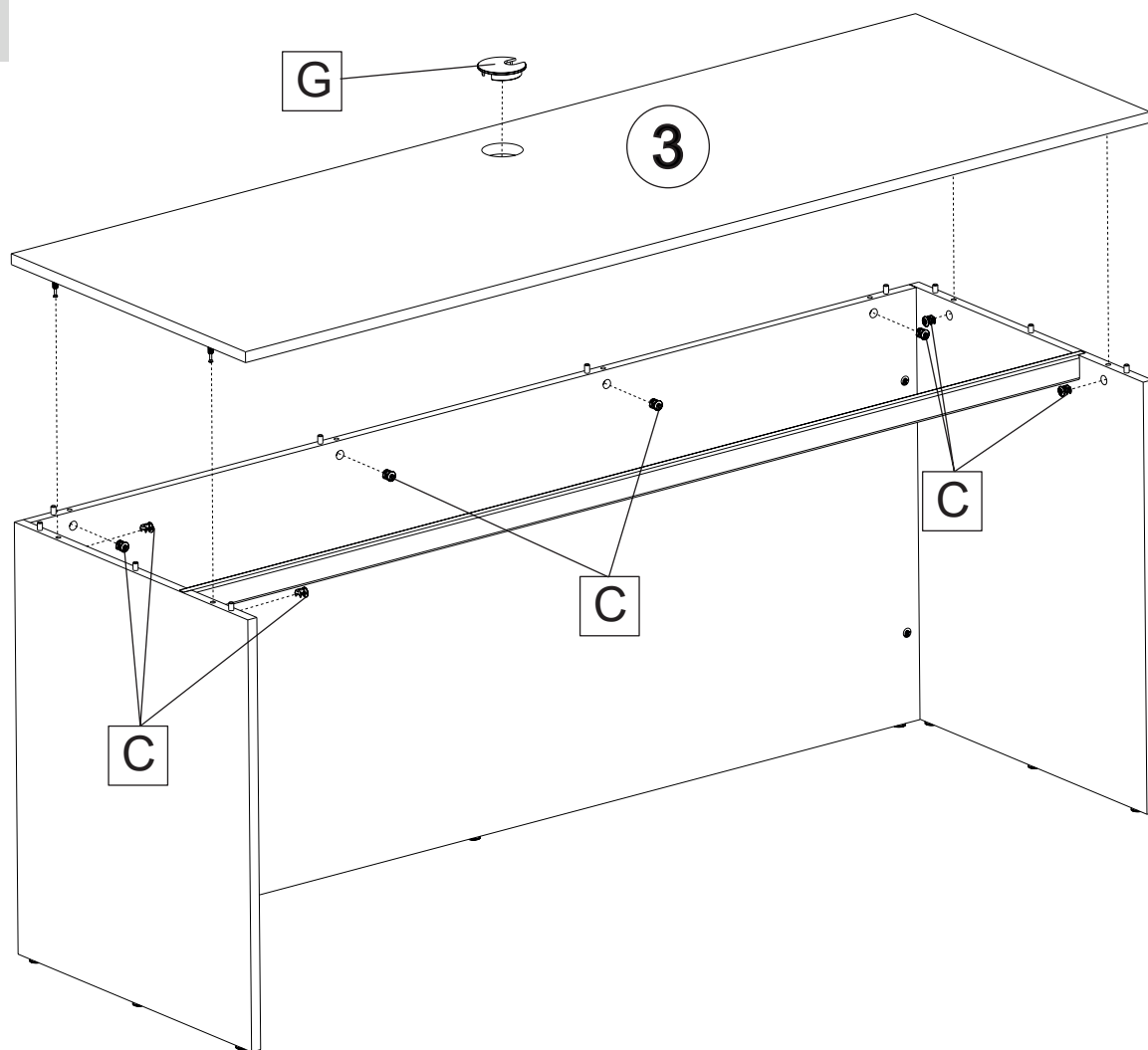

10

