

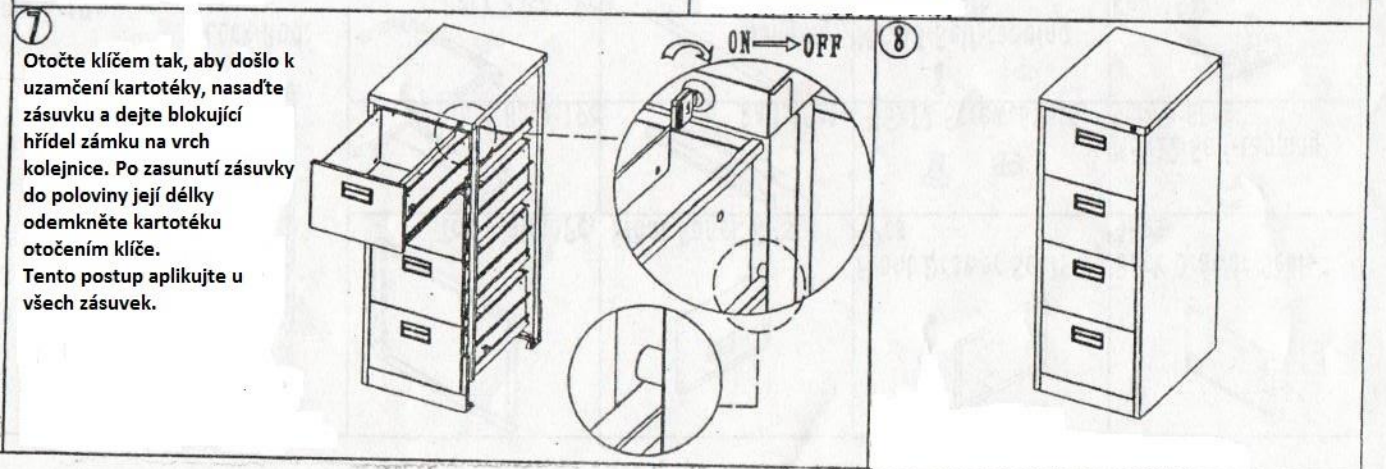

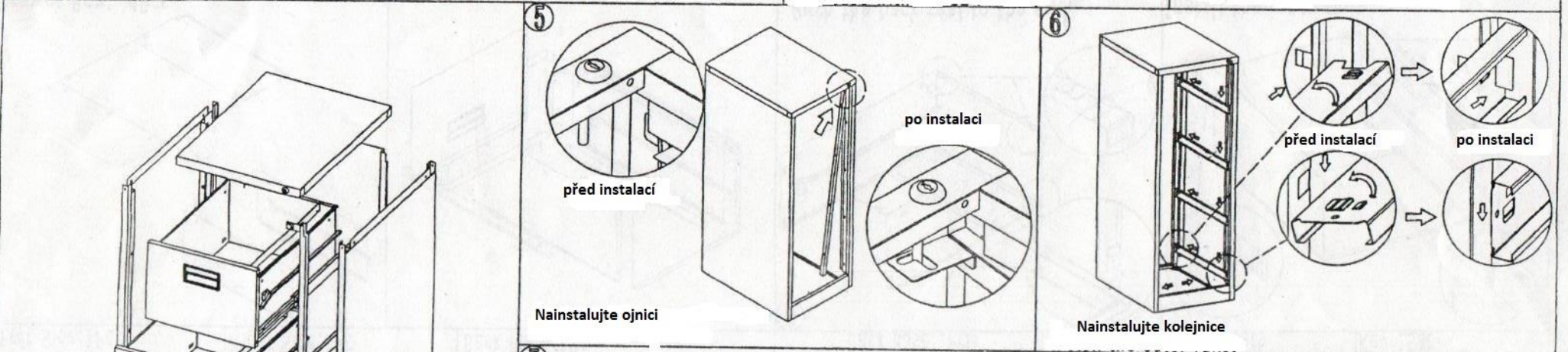

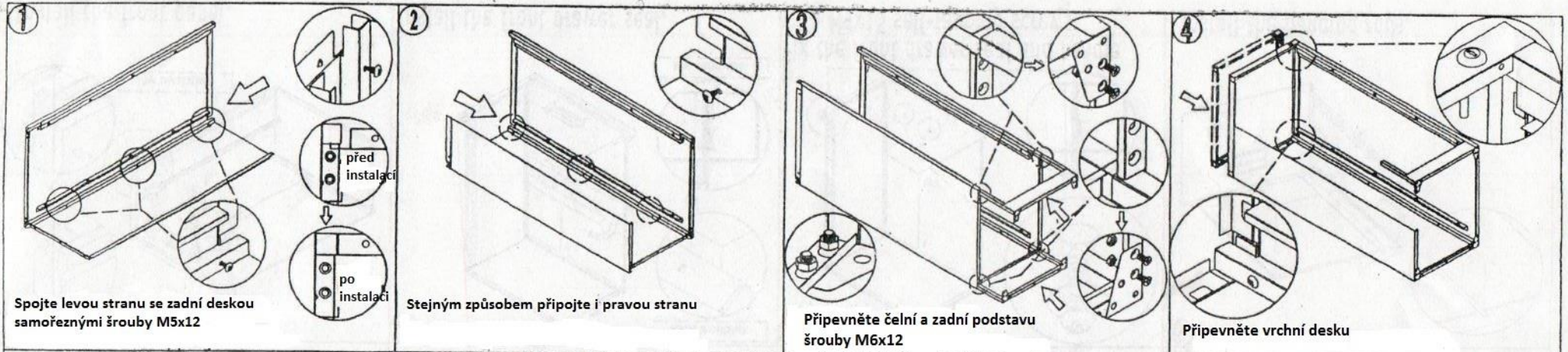





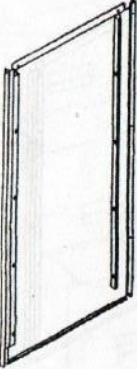



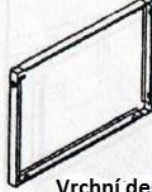

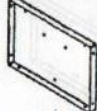
Návod k montáži

Kartotéka č. 469000



Návod k montáži

Kartotéka č. 469000

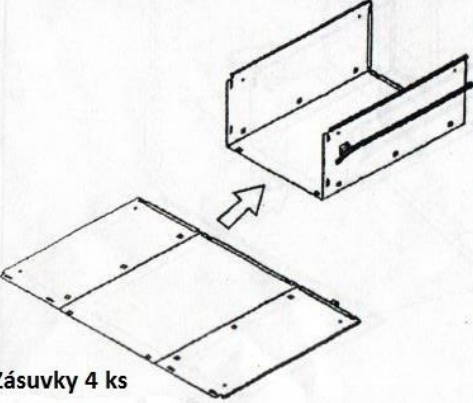
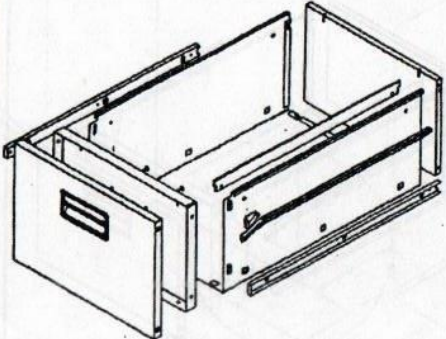
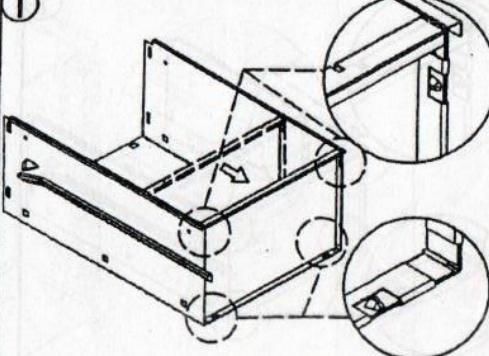
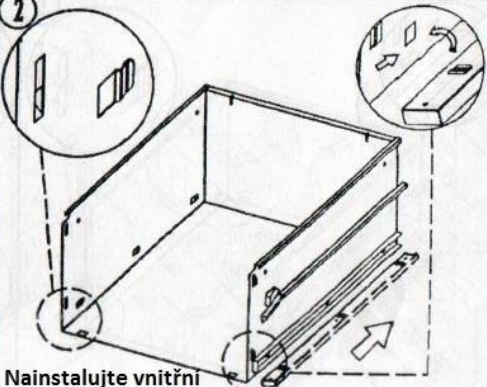
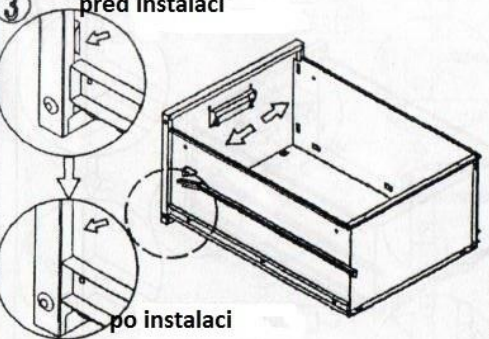
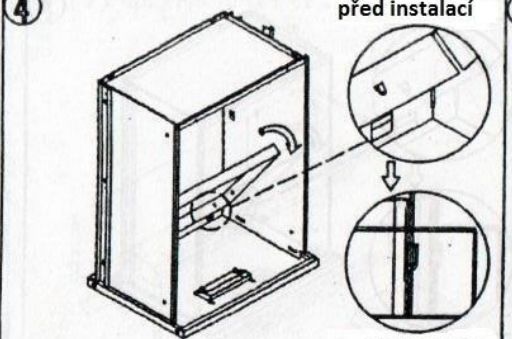
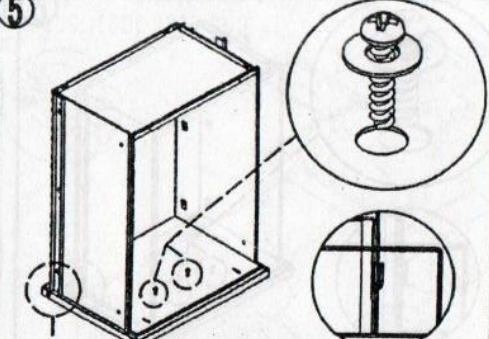
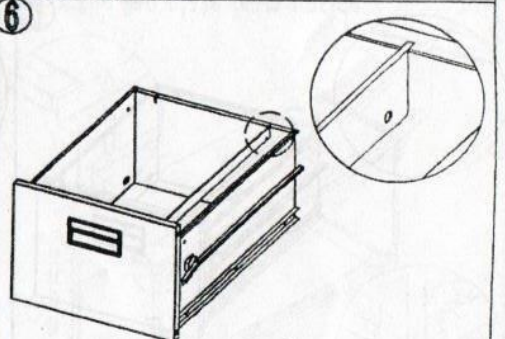
 <p>Levá strana 1 ks</p>	 <p>Pravá strana 1 ks</p>	 <p>Zadní strana 1 ks</p>	 <p>Ojnice 1 ks</p>	 <p>Vrchní deska</p>	 <p>Přední panel 4 ks</p>	 <p>Plomba přední části zásuvky 4 ks</p>	 <p>Plomba zadní části zásuvky 4 ks</p>			
				 <p>Čelní podstava 1 ks</p>	 <p>Kolejnice 4 ks</p>	 <p>M6x12 šrouby, 8 sad</p>	 <p>M5x12 Samořezné šrouby 6 ks</p>			
				 <p>Zadní podstava 1 ks</p>	 <p>Závěsné latě 4 ks</p>	 <p>M4x15 samořezné šrouby 8 sad</p>	 <p>1 sada klíčů</p>			
 <p>Zásuvky 4 ks</p>				<p>1</p>  <p>Natlačte plombu zadní části zásuvky na konec zásuvky</p>		<p>2</p>  <p>Nainstalujte vnitřní kolejnice</p>				
<p>3 před instalací</p>  <p>po instalaci</p> <p>Nainstalujte přední panel</p>				<p>4 před instalací</p>  <p>po instalaci</p>				<p>5</p>  <p>Připevněte přední plombu zásuvky samořeznými šrouby M4x15</p>		<p>6</p>  <p>Nainstalujte závěsné latě</p>